

The Story of  
**CHEMISTRY**

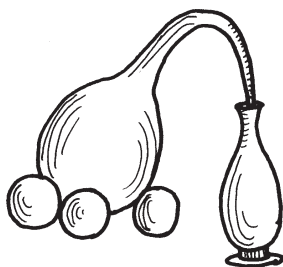

Anirban Hazra

Design: Madhuvanti Anantharajan

Pune, India, 2006



## Preface

*The Story of Chemistry* is about the development of chemistry from antiquity, to the modern science it is today. Our aim is to make the history of chemistry accessible to a wide audience, including school students and non-specialists. We hope our readers enjoy the informal and graphic presentation of the book.

In the interest of lucidity, we have taken certain liberties in the layout of the book. For example, text in quotation marks associated with a scientist may not be verbatim quotes, but rather, a simplified presentation of the idea. Readers can follow up this book with more academically rigorous works like *The Historical Background of Chemistry* by Henry M. Leicester.

The design, illustrations, layout and digitization of the book have been done by Madhuvanti Anantharajan. My discussions, debates, agreements and disagreements with her have, in my opinion, contributed greatly to improving the quality of the book. I am grateful to her for being a fantastic partner in this project.

Our book would not have been possible without the generosity and help of several people. Arvind Gupta at the Science Centre at the Inter University Centre for Astronomy and Astrophysics (IUCAA) has been the major driving force for this project. He participated actively at every stage, right from conceptualisation to editing. Moreover, he provided all possible logistical support for the project – introducing the author and illustrator, arranging funding and interacting with the publisher – which allowed us to focus on the writing and design of the book without having to worry about anything else. The book would not have happened without him.

We are grateful to the Science Centre at IUCAA, where most of the work was carried out. We thank Vidula Mhaiskar, Ashok Rupner, Samir Dhurde and Arvind Paranjpye for their support, and for staying back late on several occasions to allow us to work. An added thank you to Vidula for her help with the illustrations and the periodic table at the end of this book.

We thank Awanti Seth Rabenhøj, N. Madhavan, Venu Govindu, Sonali Shah and Amrita Hazra for editing the book and suggesting improvements.

My parents, both scientists, have been a constant source of encouragement and have provided valuable inputs for the book. Also, from a very early age, they have inculcated in me an interest and excitement for chemistry.

We thank Jamshedji Tata Trust for financial support for preparing the manuscript of the book.

Pune, India, 2006

Anirban Hazra





# CHEMISTRY

is happening all around us! The sun gives us light and heat, trees grow, animals eat food to produce energy and dead matter rots. All these are chemical processes. Thousands of chemical reactions are happening in our own bodies all the time – digestion, seeing with our eyes, feeling with our fingers, growing, getting old – each of these involves many many chemical processes.



Though these processes have been around for millions of years, it is only quite recently that we have begun to understand them the way we do today. The science which seeks such understanding is CHEMISTRY.

## Chemistry is the **SCIENCE OF MATTER.**

– the science dealing  
with the composition  
and properties of  
substances, and the  
changes they undergo.



There is another very significant side of chemistry, that is, its application by humans. The impact of this can be seen all around in our life today. Metals, construction materials, soaps, medicines, paper, plastic...

You mean if it wasn't for chemistry, I'd never have to read OR take a bath??!

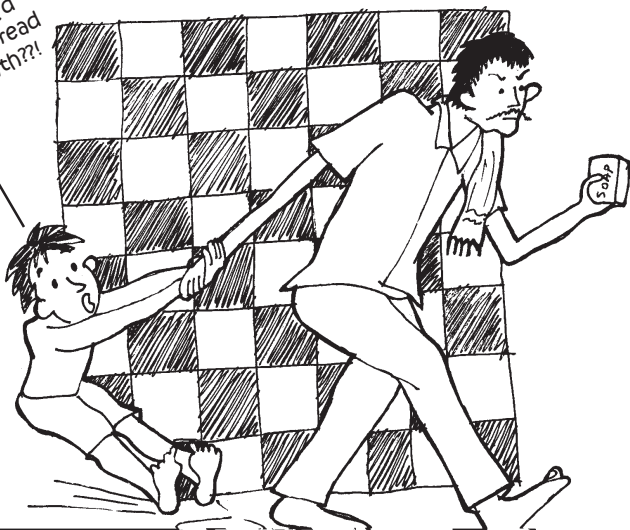

...not to mention weapons of destruction, come to us through chemical processes.

CHEMICAL RESEARCH TODAY IS VERY DIVERSE. IT INCLUDES, AMONG OTHER THINGS, DEVELOPING A BETTER UNDERSTANDING OF HOW SUBSTANCES REACT, HOW INFORMATION OF HUNDREDS OF BOOKS CAN BE STORED ON A TINY SILICON CHIP, WHAT NEW FUEL CAN SUPPLY OUR ENERGY NEEDS WHILE SAFEGUARDING OUR ENVIRONMENT AND HOW DRUGS CAN BE DESIGNED FOR A SPECIFIC PURPOSE.

To reach this stage of sophistication, Chemistry has gone through a long and exciting journey.

In this book we will explore  
this fascinating history of  
chemistry

Let us begin by going back some

100,000 years...

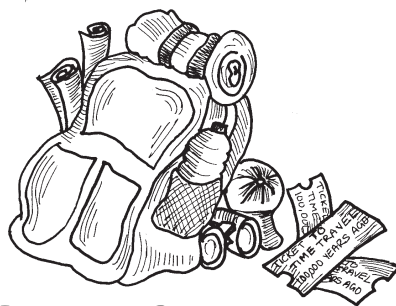

Humans were already using

# FIRE

– the timeless chemical transformation! The ability to use fire greatly increased the chances of human survival. Fire kept away predators, provided warmth in the winter and was used for cooking food.

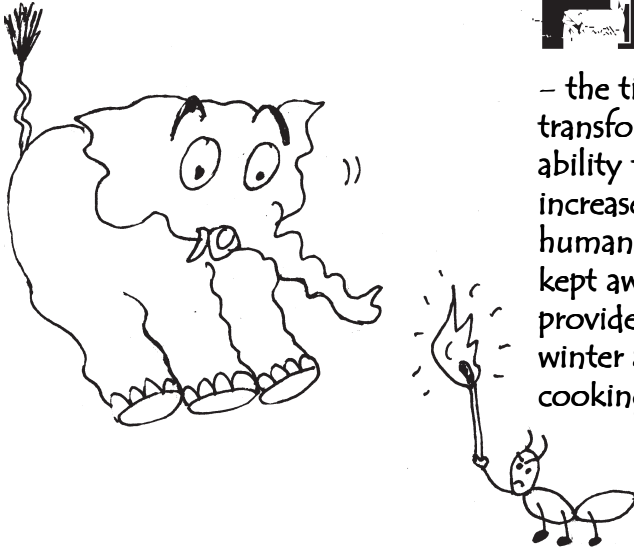

It was only a question of time before it was discovered that fire, apart from cooking food, brought about other transformations too.





5,000 B.C.

This is a conversation that could have happened around this time...

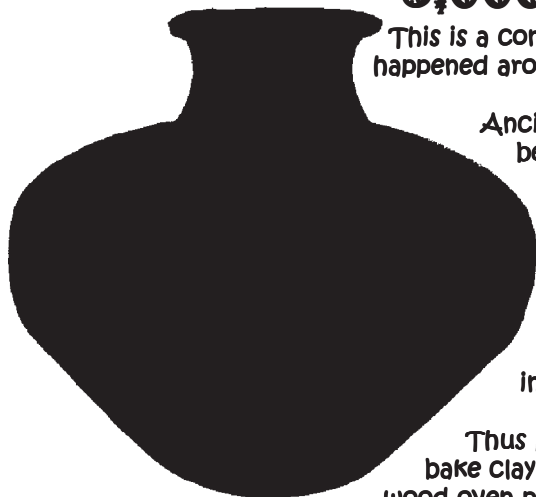

Ancient person 1: This wet clay below the fire has become hard and it does not get washed away by water.

Ancient person 2: That gives me an idea. Let us give the clay a shape and put it in the fire so that we can store things in it.

Thus pottery was born. To routinely bake clay pottery, the kiln was made – a wood oven producing a steady and high temperature.

One day, an artist potter decorated a pot with some small green coloured pebbles before inserting it in the kiln. On removing the pot from the kiln, something remarkable had happened.

The pebbles had melted and they were shining!

The decorative stones were actually metallic ore. They had been converted to **METAL** in the reducing atmosphere of the kiln.

More of the metal was obtained from the coloured stones by heating in the kiln and it was found to have curious properties.



This shiny stuff is great! It does not break like stone. It flattens out on beating and I can give it whatever shape I like.



Metals came into wide use for decorative items and tools. Different combinations of substances were heated in kilns in order to extract metals.

The metals used were often

alloys. **BRONZE**

(a mixture of copper and tin) was used most extensively.



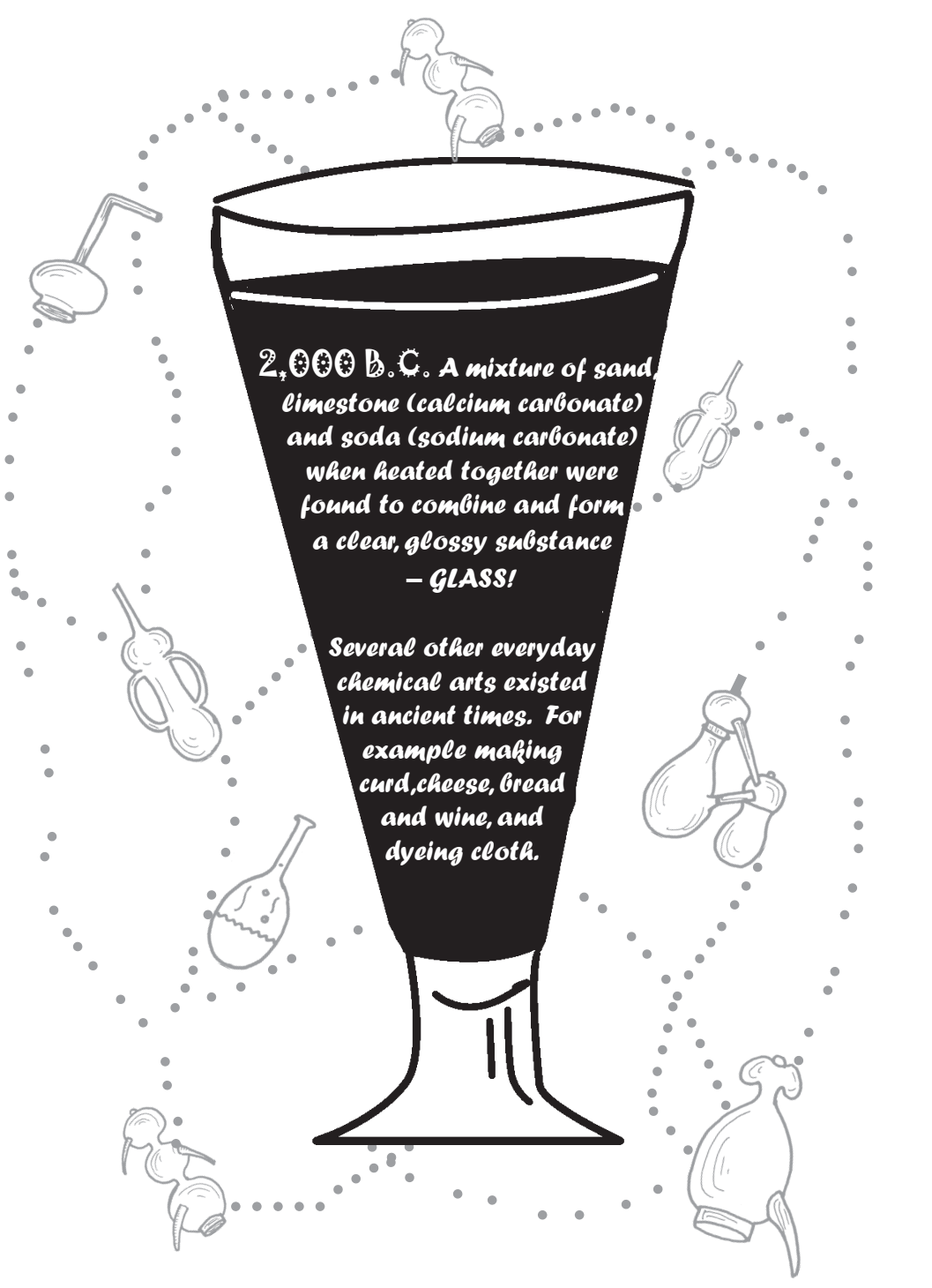

**2,000 B.C.** A mixture of sand, limestone (calcium carbonate) and soda (sodium carbonate) when heated together were found to combine and form a clear, glossy substance – **GLASS!**

Several other everyday chemical arts existed in ancient times. For example making curd, cheese, bread and wine, and dyeing cloth.

Humans developed technology and arts to make food tastier and life more comfortable. But there is another side to our nature – enquiry into causes of phenomena.

The earliest explanations of natural processes were in terms of **gods, demons, spirits** and the like. In a tribe, there would be certain people – the priests, witch-doctors and medicine men and women – whose business it was to understand these supernatural forces and appease them.

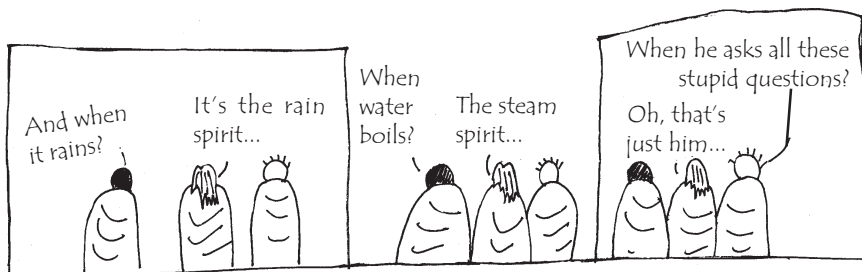

As civilizations evolved and division of labour became more specialized, this group became more set apart. It did not have to do much manual work and had the leisure to speculate on the nature of the world. This group of people, the early philosophers came up with the first scientific theories.



The development of the first theories of chemistry began around the 6<sup>th</sup> century B.C. in at least three civilizations, namely Greek, Indian and Chinese. Of these, the work of the Greeks is most documented and the dates associated with the events are known quite accurately. That is why we will look more at the theories of the Greeks.

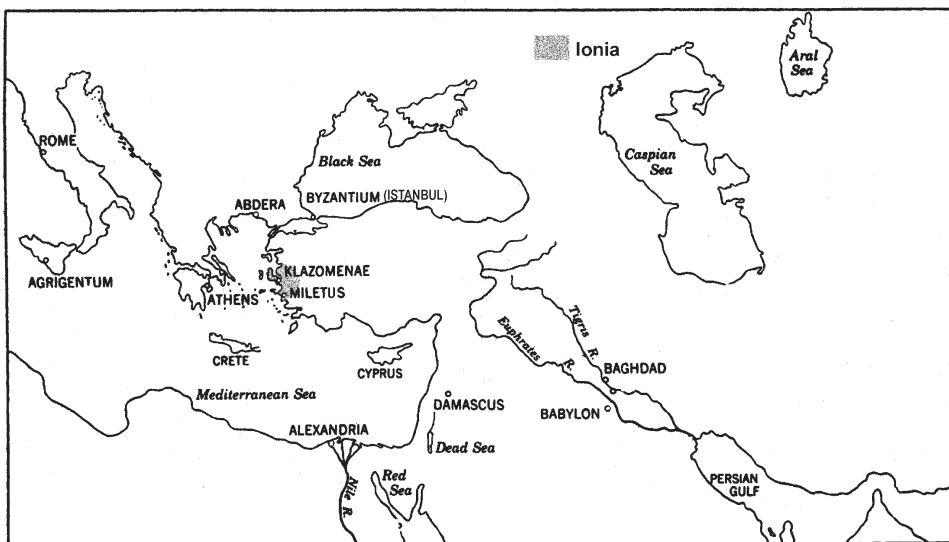
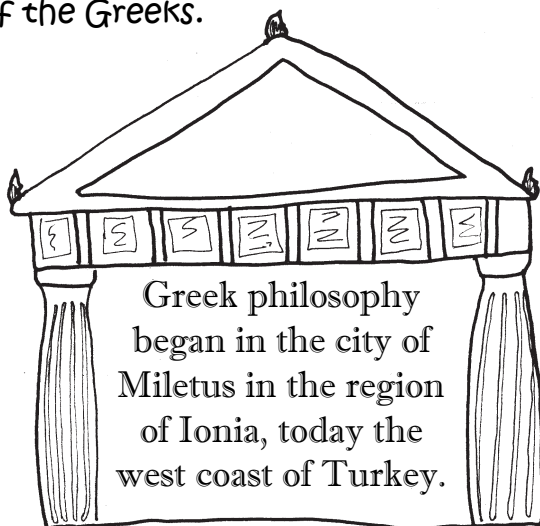

“Can everything be regarded as a single reality, appearing in different forms?”



Thales of Miletus  
(c. 640 — 546 B.C.)

“Yes, there is a single reality in nature and it is water. It can be converted to air (evaporation) and congealed to a solid. It can therefore serve as the origin of all things.”

The states of matter — ~~gas~~, **liquid**, **SOLID** — and their interconversions, were the basis for explaining all changes in nature.

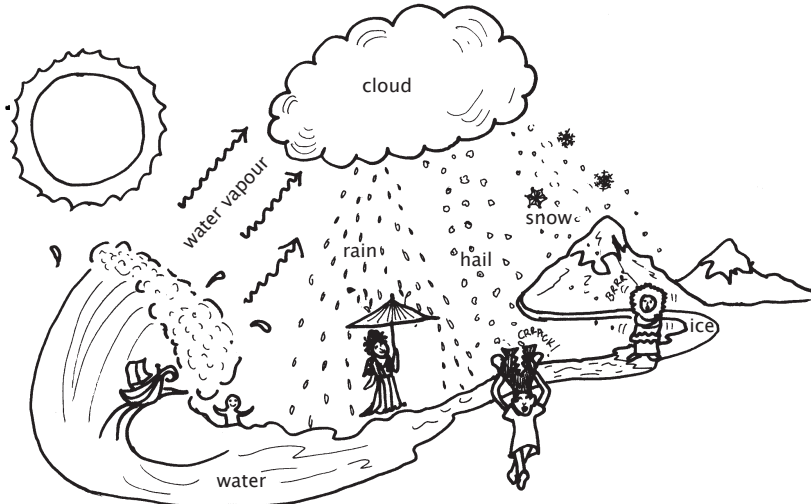

Others philosophers in Ionia chose different first sources like air, fire or a formless infinite substance,

**APEIRON**

The last well known philosopher in Ionia was

**Anaxagoras** of Klazomenae. He assumed that the world is made up of an infinite number of minute particles which he called "seeds".



"Seeds contain extremely small portions of everything that exists in the visible world. The amounts of these are variable in an individual seed. Seeds which contain more wood, for example, tend to group together to form wood."

An individual seed which we find in a piece of wood would look like this. It has portions of all kinds of stuff, but the largest portion in it is wood.

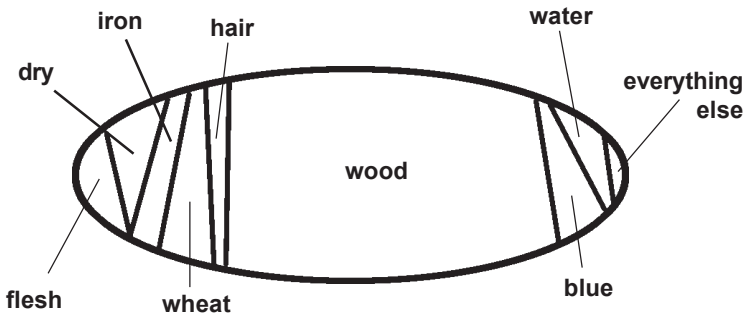

**Empedocles of Agrigentum** in Sicily (c. 490 – 435 B.C.): "All visible objects are composed of minute unchanging particles or roots which are of only four types – **Fire, Air, Water** and **Earth**. Two additional components of all objects are **Love and Strife**. Under the influence of Love the elements combine and under the influence of Strife they separate."



Before Empedocles, air was often considered a transition between water and fire, and not really a material substance. Empedocles recognized that air is material and showed this by experiment. He used a **clepsydra**, a vessel with two holes – one at the bottom and one on top. When he placed the bottom hole of the vessel under water, Empedocles observed that the vessel filled up with water. If, however, he put his finger over the top hole, then the water did not enter the hole at the bottom. Once he removed his finger water entered and air rushed out. The experiment demonstrated that the air in the container prevented the water from entering.



## Democritus of Abdera (c. 460 - 370 B.C.)

"All matter is composed of collections of infinitesimal and indivisible particles, that is atoms (*atomos* in Greek means indivisible). The atoms of the four elements, earth, air, water and fire have physical size and shape which explain many of their properties. The atoms of fire are round balls which do not mix with the other elements. The atoms of air, water and fire have geometrical shapes and can become entangled with each other to produce visible substances."

The idea of atoms, which has similarities with modern ideas, is thus ancient. However during that time, it was pure speculation just like any other Greek theory and did not make any special impact.

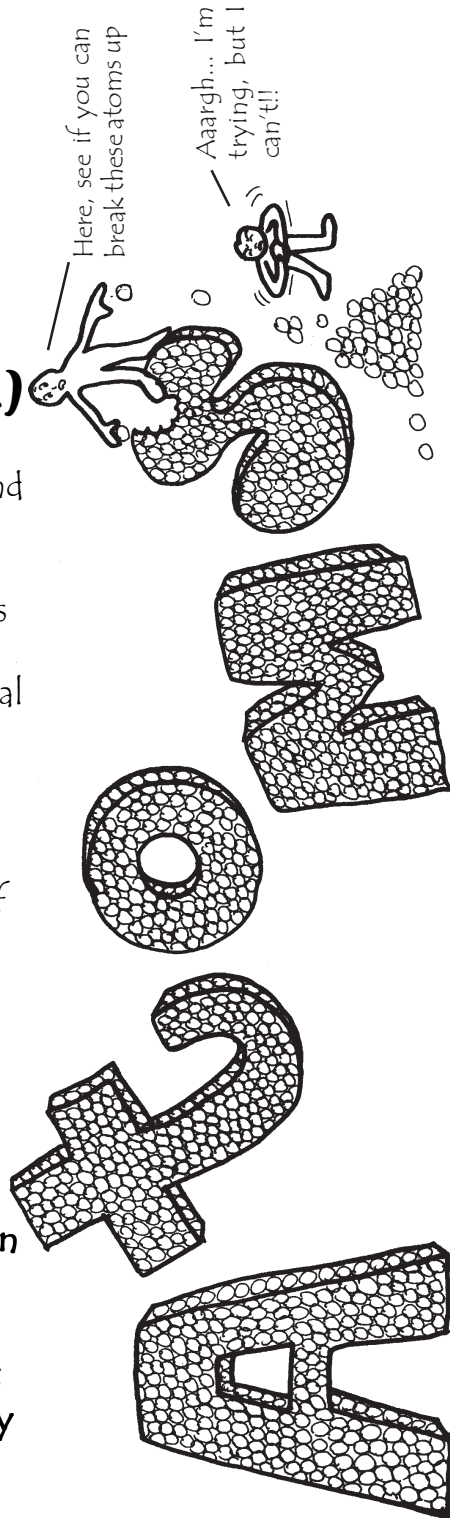

The most influential Greek philosopher was **ARISTOTLE** (384 – 323 B.C.), who is also well known as the tutor of Alexander the world conqueror. Aristotle built up a great body of self-consistent theories (i.e. theories that do not contradict each other) attempting to explain all nature in a more detailed fashion than any of his predecessors.

“The basis of everything is *prote hyle* the fixed and unchanging “first matter” on which are impressed the specific qualities that give a substance its characteristic form. There are four qualities – heat, cold, dryness and moisture. These can be combined to form six couples. However, contraries – hot and cold or moist and dry – cannot couple. Therefore, only four couplings are possible. These give four elements, which make up all earthly matter.”

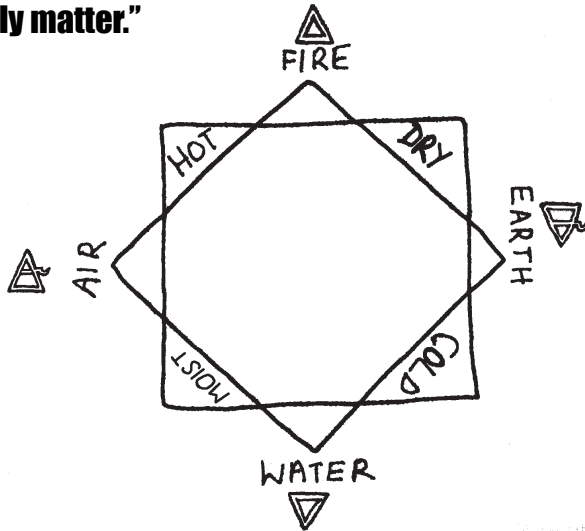

**Hot + Dry = Fire**  
**Hot + Moist = Air**  
**Cold + Moist = Water**  
**Cold + Dry = Earth**

“Besides these four elements which make up all earthly matter, there is a fifth element “ether” which is the more ideal element, the perfect form, and of it the heavenly bodies are composed.”

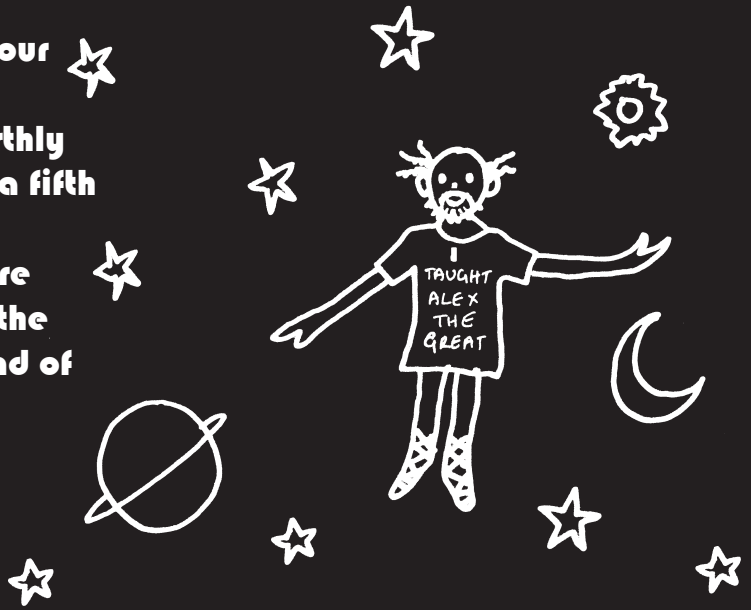

These qualities could be varied to any degree, and so it was possible to transform any element into any other. For example, to convert water into air, it is only necessary that the cold be overcome by heat, since the moist is common to both.





In **India** and **China** too, theories of matter were developed, starting around the fifth century B.C.

**Kapila**, one of the oldest Indian philosophers said, "There are **five bhutas** or classes of substances – **Akasha** (space or ether), **Vayu** (air), **Tejas** (fire), **Ap** (water) and **Kshiti** (earth). These substances are made up of **Anu** or atoms and these are further made up of intra-atomic particles. The difference in grouping of intra-atomic particles, give rise to the different properties of substances."



"Classes of substances??!  
I never knew that! I thought we bhutas were just spirits who like to scare you folks and have a bit of fun!"



**Kanada**, another Indian philosopher suggested: “Akasha or ether has no atomic structure; it is inert and ubiquitous. There are four kinds of atoms air, fire, water and earth and these combine with each other to form molecules. The variety of substances is the consequence of the difference in the molecular composition. Heat corpuscles cause transformation of substances.”

The Chinese had a theory of the constitution of matter based on 5 elements:

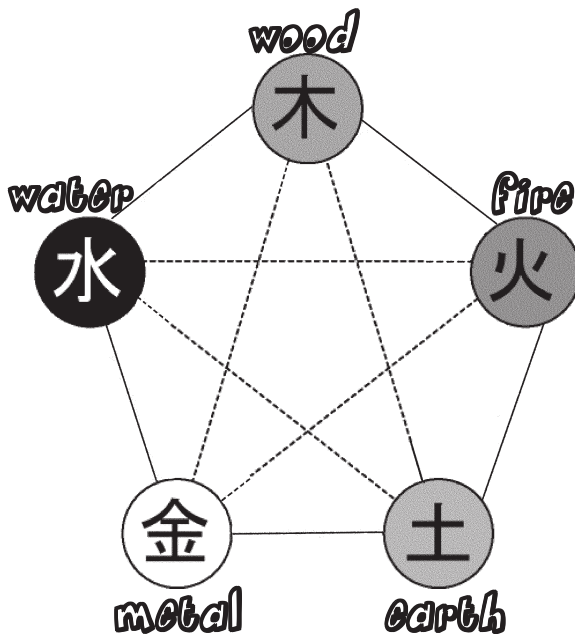

The combination of these gave rise to all material substances. Properties of these substances were summed up in the two great contraries: YIN the female principle associated with the moon, night and heavy, and YANG the male principle associated with the sun, day and light.

In Aristotle's later years, his famous pupil **ALEXANDER** (356 – 323 B.C.), set out to conquer the world. His conquests brought the world closer and allowed different philosophies, religions and ideas to mix. A common culture – the so called Hellenistic culture – spread in the whole of the area around West Asia. In this melting pot arose the new idea of alchemy.

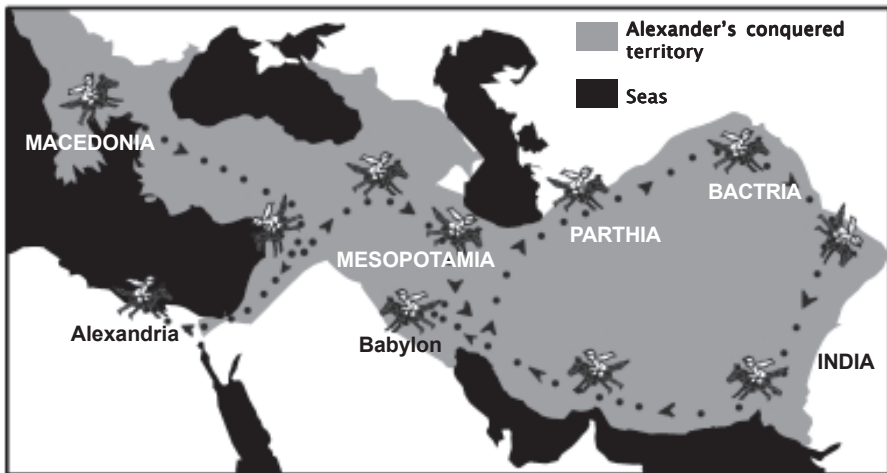

Alexander's conquest route

## 1<sup>st</sup> century A.D.

Alexandria, a settlement founded by Alexander at the mouth of the Nile became a chief centre of intellectual activity.

**HERO** (c. 52 – 150 A.D.) developed mechanical devices like a steam engine and a mechanism that would deliver holy water when a coin was deposited (a slot machine). He studied the nature of gases and in many respects anticipated the kinetic theory of gases.



Hero's steam engine may have looked like this...

In Alexandria, a number of eastern mystical religions established themselves and these influenced the natural philosophers. Also present were the artisans who produced the luxuries for the wealthy classes and the temples. The artisans came in contact with the theories of the philosophers and from this union of theory and experiment came a totally new growth...

# ALCHEMY

Alchemy was thus a result of various ingredients – **Greek and eastern philosophies, elements of mysticism, and Egyptian technology**

Alchemy was grounded in Aristotelian ideas. One of these was that all things tend to reach perfection and this implied that among the metals, the less perfect were always striving to reach the perfection of gold.

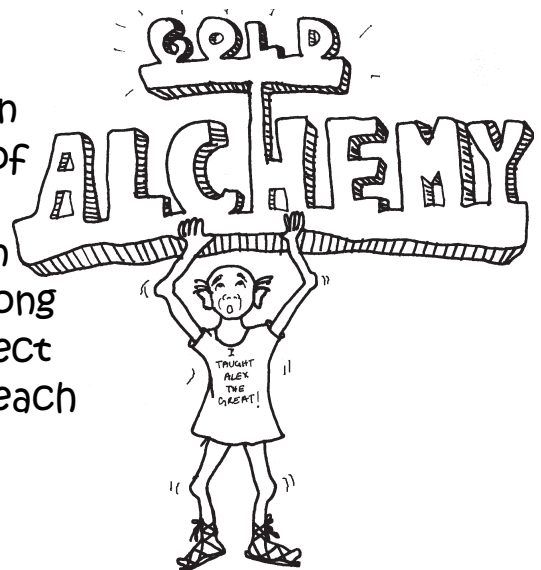

Nature carried out this perfection process of creating gold deep in the earth and over a long period of time. The artisan in his workshop could repeat much of this process in a relatively short time by improving his methods and make pure gold with his own abilities. This was the basic idea of alchemy.



“We know how to convert rocks to metal – since we can do that, I am sure we can convert a less perfect metal to gold as well. I am certain that a metal which closely resembles gold, is actually a form of gold. It may be somewhat less perfect, but with only a little effort it can be transformed into the perfect metal.”



***Alchemy was thus an extension of the metallurgical practices of the day.***



**COLOUR** of the metal was considered a fundamental property.

"We, of course, want yellow metal. We will extract the 'spirits' of eggs, which on distillation will yield a substance (which people will later call sulphur) that will colour metal yellow."

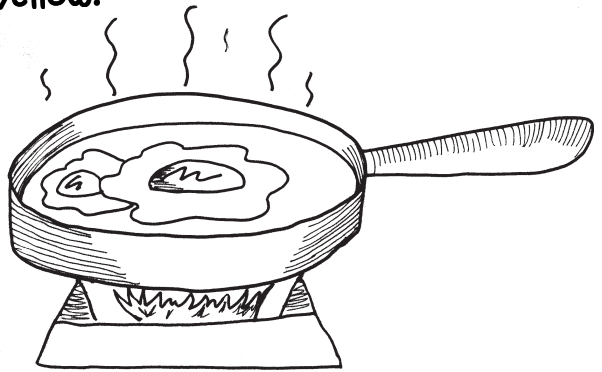

Later...



Well, that didn't work, but I think I just invented the omelette!

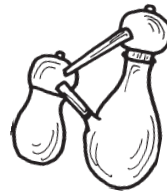

Alchemy developed in parallel in China with its basis in Taoism, a school of philosophy founded by Lao Tzu in the **6<sup>th</sup> century B.C.** The Chinese alchemist wished to make gold not merely for the sake of gold itself. He believed that by eating gold, or some similar preparation, he could attain eternal life and have limitless powers. There is thus a considerable amount of alchemical literature on methods of consuming gold to achieve immortality.

That's a nice pendant!

Oh, it's actually my lunch

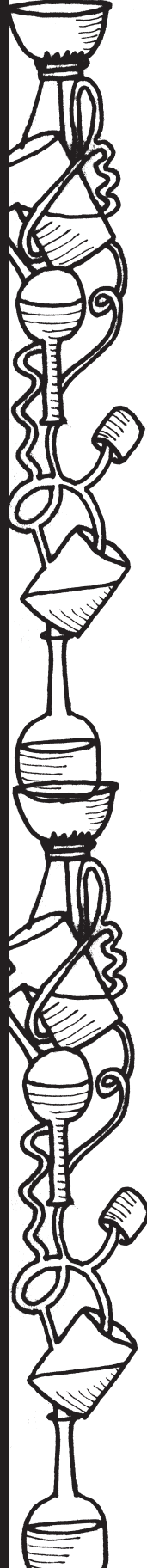

The name **CHEMISTRY** initially makes its appearance in the earliest alchemical recipes around the first century A.D. It may have come from the Egyptian word "khem", which is the ancient name of Egypt and which was a prominent centre for chemistry at the time.



A second theory is that chemistry comes from the Greek "cheo", which means, "I cast", or "I pour", and refers to the metallurgical operations of early chemists. Yet another suggestion is that chemistry is derived from the Chinese "chin-i", pronounced "kim ya", which means "gold making juice".



About **300 A.D.**

Alchemy spread from Alexandria to Syria, Mesopotamia (Iraq) and Persia (Iran).

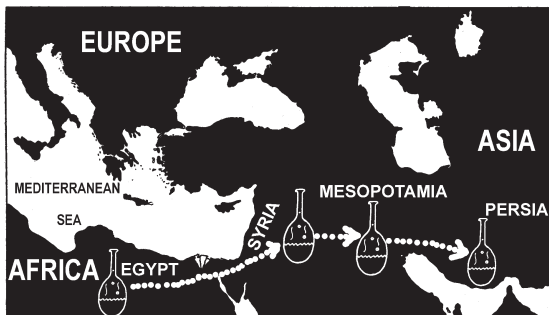

**622 A.D.**

Islam spread rapidly through all Arabia. Around this time scholarship flourished. The Arabs inherited a rich intellectual legacy from the Greek and the Chinese. The addition of the Arabic definite article "al" or "the" gave the word alchemy – meaning "the Egyptian science".

## Jabir ibn Hayyan (Geber) (c. 721 – 815)

was the most celebrated of the Arabian alchemists. According to the Jabir system heat, cold, dryness and moisture were actual natures which had an independent and concrete existence. So for example pure Cold could be obtained separately. The task of the alchemist was to determine the proportion in which these natures entered into substances, to prepare the pure natures, and to combine them in the proper amounts to give the desired products.

In an attempt to prepare pure natures, many chemical operations and practical laboratory apparatus were developed. The Jabir works describe the destructive distillation of a very large number of substances including animal products. It was also believed that silver can be converted to gold by using an "elixir".

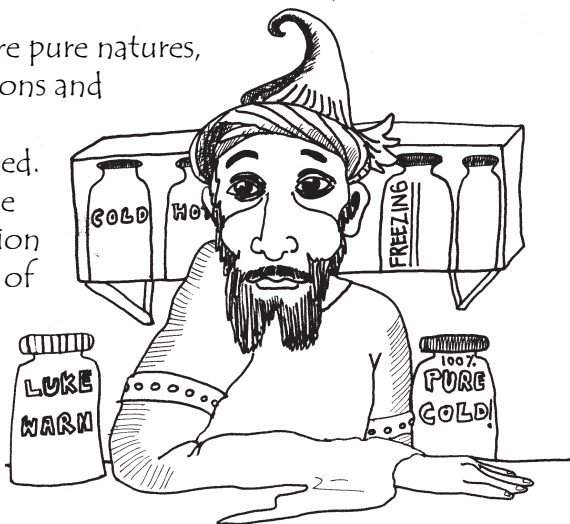

But the Big Question still remainedoooo

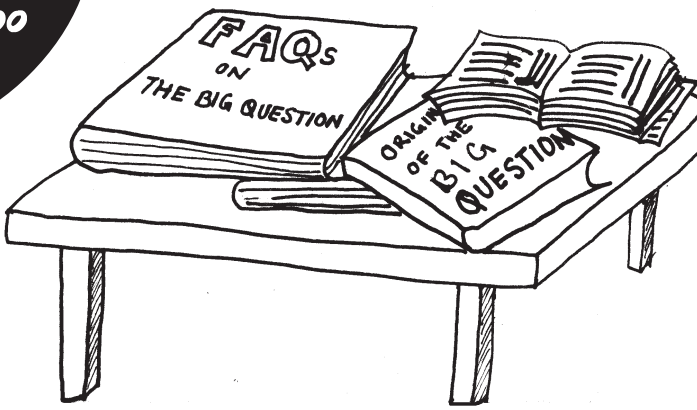
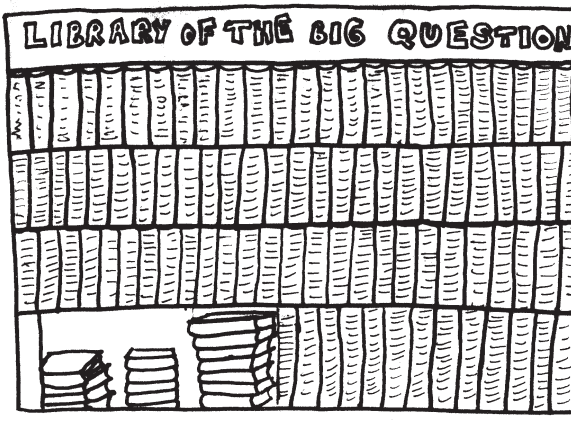

The big question is,  
"How do we make the  
**ELIXIR?**"



**AL-RAZI (RHAZES)** (c 860 – 925), another great name in Arabian alchemy, was a physician who in his work brought a practical, scientific approach to chemistry. His writings were free from mysticism and allegory. They contain discussions of apparatus, classification of substances and technical recipes. A major contribution is the recipes for sharp waters, that is alkalis and acids which can be used as solvents for metals and other substances.



Hello, I am Abu Bakr Muhammed ibn Zakaria al-Razi. But you can call me al Razi. Here is my recipe for preparing sharp water:

Take equal parts of calcined *al-Qili* (sodium carbonate) and unslaked lime and pour over them 4 times their amount of water and leave it for 3 days. Filter the mixture, and again add *al-Qili* and lime to the extent of one-fourth of the filtered solution. Do this 7 times. Pour it into half (the volume) of dissolved sal ammoniac. Then keep it; for verily it is the strongest sharp water. It will dissolve *Talq* (mica) immediately.

## 11<sup>th</sup>, 12<sup>th</sup> and 13<sup>th</sup> centuries A.D

A number of alchemical books and commentaries on older writings came out, but they added almost nothing new. Mystical ideas prevailed and science in this region lost its drive. Fortunately, at this time Western Europe, which would have been quite unready to receive Greek scientific ideas at an earlier period, was able to accept the theories of the Arabs and thus the tradition of science was not lost.

The theories of the Arabs were now passed on to the West. A large number of Arabic alchemical manuscripts were translated to Latin. Western Europe now took over as the chief centre for alchemy.



Better glass was used,  
developed by artisans in  
Italy and distillation  
apparatus was improved.

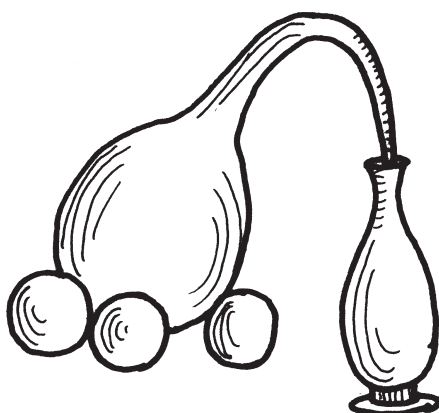

It became possible to prepare strong solutions of alcohol, which was known as *aqua vitae*, water of life. Nitric acid and aqua regia, an acid (mixture of nitric and hydrochloric acid) which dissolves gold became common reagents and were produced on a large scale. This greatly increased the power of the chemist to dissolve substances and carry out reactions in solution.

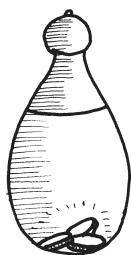

hydrochloric acid

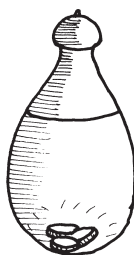

nitric acid



aqua regia



# An alchemist's lab



# GUNPOWDER

was manufactured and used in warfare. This would have large implications for society and it is felt that to a large extent it was responsible for the overthrow of the feudal system in Western Europe (The actual invention of gunpowder took place in China in the 10<sup>th</sup> century).

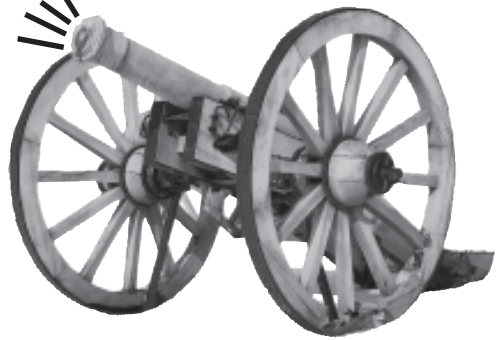

## 14<sup>th</sup> and 15<sup>th</sup> centuries A.D.

There was a lot of activity, but most of it centred around experiments following old alchemical recipes. Alchemists produced more and more manuscripts, which merely repeated earlier ideas in different words.

They worked like madmen, often in secret. They hoped to fashion the “philosopher’s stone” – a mythical substance which could turn baser metals to gold.

***But every time the day for testing came...***

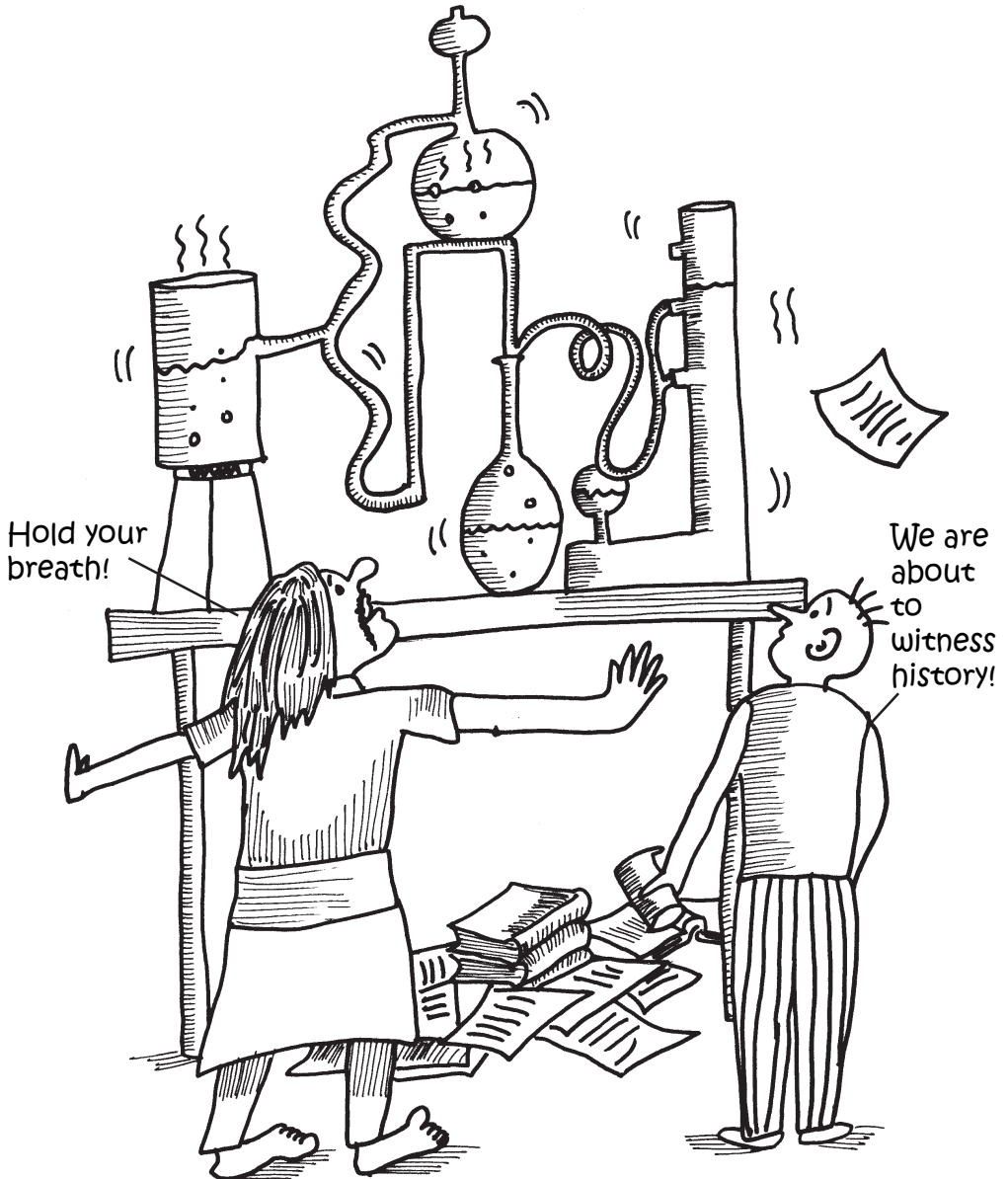

**POOF!**

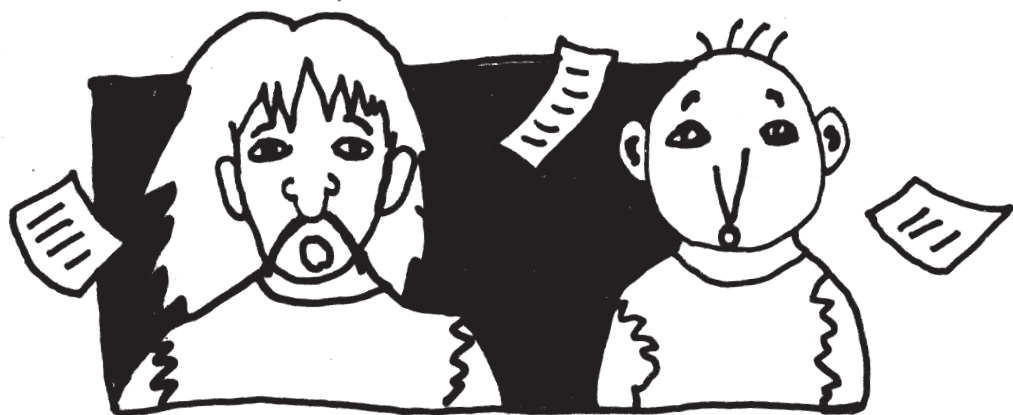

*The story was always the same...*

***Failure!***

There was an increasing tendency toward allegory and mysticism, and charlatans were frequent. Alchemy had reached a dead end now.

**“It’s time to admit it now – TO MAKE GOLD, ONE MUST START WITH GOLD!”**

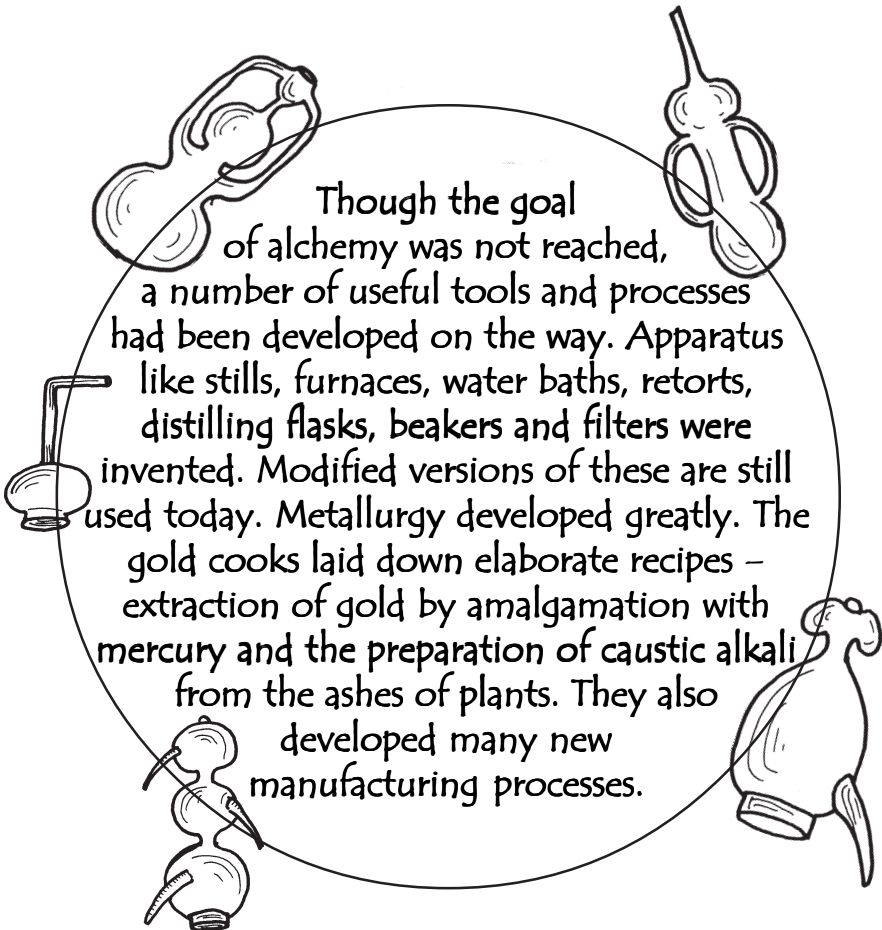

# 16<sup>th</sup> century A.D

The work of practical chemists took chemistry forward. Quantitative methods in metallurgy like assaying (analysing an ore or alloy to determine the quantity of particular metals in it) and testing ore quality developed. Books were published which gave detailed descriptions of the practice of mining, the treatment of ores, and the preparation of reagents. This was a period when the technological branch of chemical science progressed while the theoretical side remained relatively inactive.

In **1500**, **Hieronimus Brunschwig** (c.1450 - 1513) published an important book, the ***Liber de arte distillandi***. The book contained an exposition of the methods and apparatus of distillation of plant or animal products, mainly by steam. The book reveals great originality; primarily because of the description, complemented by abundant illustrations, of chemical and distillation apparatus. Brunschwig frequently used a water bath in his distillations, and condensed the plant essences in a conical alembic cooled by air, which was called a **Rosenhut**. -----

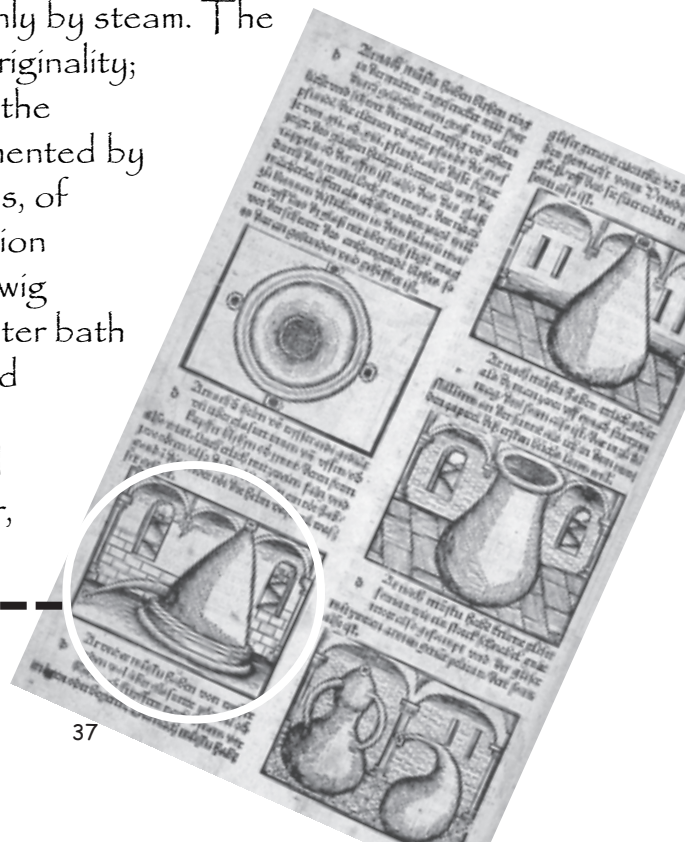

One of the controversial figures of the sixteenth century was a man called **Philippus Theophrastus Bombastus von Hohenheim** (1493 – 1541), who called himself **Paracelsus**. He laid stress on iatrochemistry, that is, the use of chemistry for healing human illnesses.

He was controversial because of his volatile temper and sharp criticism of earlier alchemists as well as doctors and apothecaries of the day. To prepare medicines, Paracelsus subjected a large number of metals to a standardised set of reactions. He thus obtained a series of salts of various metals in solution. For the first time, he generalised chemical reactions instead of considering every process as a different transformation.



# 17<sup>th</sup> century A.D

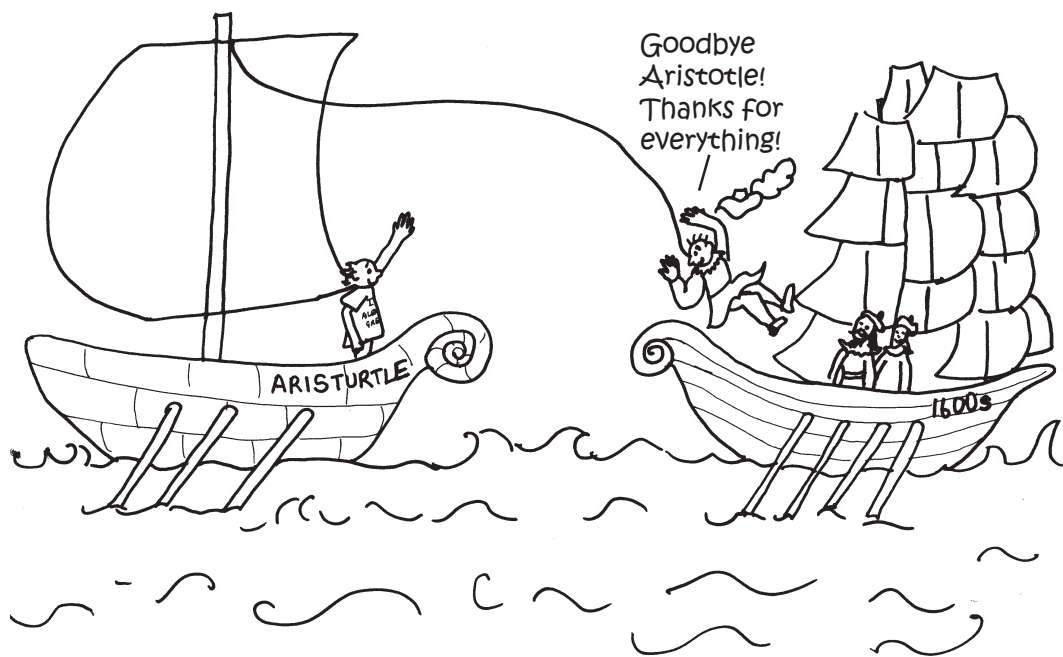

Chemistry began to assume the position of an independent science and patterns of chemical thinking and philosophy emerged. Also, some ideas, particularly Aristotelian which had stood for more than two decades underwent upheaval.

# Van Helmont (1577 – 1644)

a wealthy physician living near Brussels, spent most of his life in retirement, carrying out chemical experiments. He felt that water could be converted into other substances and to prove this he did the following experiment.

He planted a tree in a weighed amount of earth, watered it for five years, and then showed that, while the tree had gained 164 pounds, the weight of the earth remained the same.

To him, this proved that all parts of the tree had formed from water and thus that water was the basis of all chemical substances. Though the fallacy of this would be shown later, the idea of quantitative experiments was established and so was the implicit assumption that matter is not created or destroyed in the changes that it undergoes.





**JOHANN RUDOLF GLAUBER** (1607 – 1670) was self-taught in chemistry, and he wandered over much of Europe learning methods used in various countries. He eventually settled down in Amsterdam, where he constructed an excellent laboratory.



"Salts are made of two parts, one coming from an acid, the other from a metal or its earth (oxide). Salts can react with each other or acids to produce new salts. Acids have different strengths – a stronger acid reacts with a salt of a weaker acid. For example, nitric acid reacts with sal tartari (potassium carbonate) to give saltpetre (potassium nitrate) with the evolution of a gas (carbon dioxide)."

**Glauber's name comes up most often in the context of the salt sodium sulphate which he prepared and attributed marvellous powers to. It had been since known as Glauber's salt.**

IN THE 17<sup>TH</sup> CENTURY, THERE WAS A MAJOR CHANGE IN THE THEORETICAL BASIS OF CHEMISTRY. THERE WAS A SHIFT FROM THE ARISTOTELIAN THEORY THAT LED TO THE BELIEF THAT EVERY CHEMICAL CHANGE IS A TRANSMUTATION, THAT IS, THE REACTION PRODUCTS ARE COMPLETELY NEW AND NOTHING OF THE OLD SUBSTANCE REMAINS. EVIDENCE ACCUMULATED FROM EXPERIMENTS, TO INDICATE THAT THE SAME SUBSTANCE COULD PERSIST THROUGH A SERIES OF CHEMICAL CHANGES. IT WAS NATURAL TO ASSUME THAT THERE EXISTED SOME UNCHANGEABLE PROPERTY OF THE ELEMENT THAT CARRIED THROUGH ALL THE STEPS. IT WAS TIME FOR A REVIVAL OF THE ATOMIC THEORY OF DEMOCRITUS.

**Joachim Junge** (1587 – 1637), explained many reactions in atomic terms: The replacement of iron by copper, on the surface of an iron piece placed in a copper sulphate solution, is not a transmutation, only an exchange of atoms.

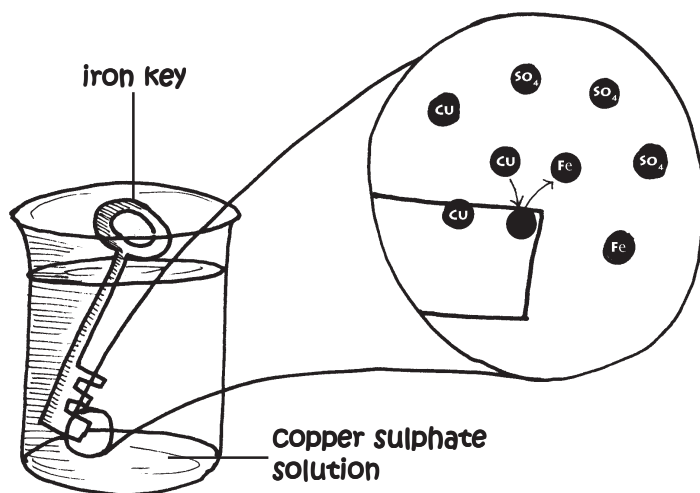

Irish-born **Robert Boyle** (1627 – 1691) was an amateur investigator working in England. Based on his experimental work he enunciated the inverse relationship of pressure and volume of gases.

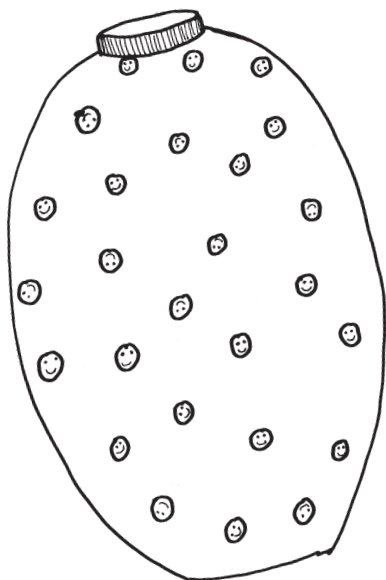

“Aaargh! Let me out! I can’t take the pressure in here anymore!”



Boyle said, “**Corpuscles – small, solid, physically indivisible particles are the building blocks of nature. Corpuscles are associated into larger groups through a number of chemical reactions. These groups act as units and the size, shape and motion of these units give substances their properties.**”

Democritus’s idea of atoms was back. Boyle however did not use the word, rather choosing to use corpuscles. Boyle attempted to present a mechanical picture of chemical reactions, doing away with the idea of forms and qualities of Aristotle.

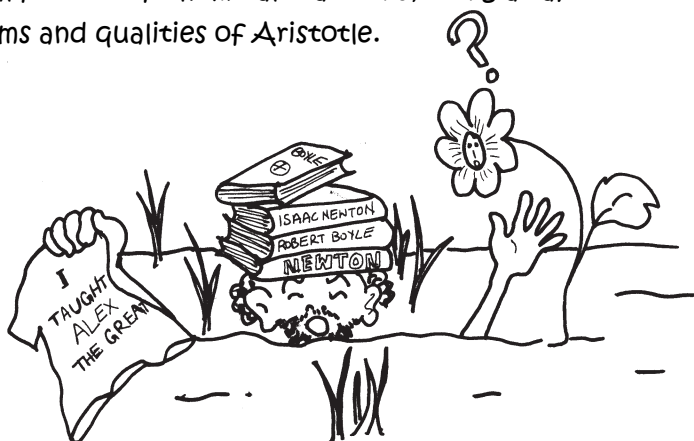

Boyle's famous book *The Sceptical Chymist* published in 1661 presented convincing arguments to destroy most of the older ideas. The book is written in a rather prolix style and enlivened with touches of humour, as when the alchemists are compared with "the Navigators of Solomon's Tarshish Fleet, who brought

home . . . not only Gold, and Silver, and Ivory, but Apes and Peacocks too", since their theories "either like Peacock's feathers make a great show, but are neither solid nor useful; or else, like Apes, if they have some appearance of being rational, are blemished with some absurdity or other which makes them appear ridiculous." The book was extremely influential in establishing a newer outlook among Chemists of the 17<sup>th</sup> Century.

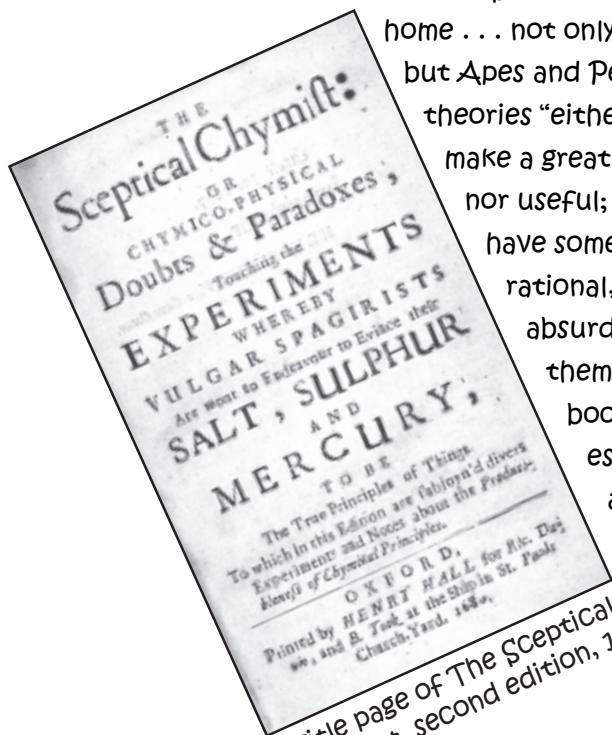

Title page of *The Sceptical Chymist*, second edition, 1680

In the 1640s, scientists began organizing groups to meet and discuss the problems they faced in their laboratories. At first these were informal meetings and they led to formal organizations. One such group was the Invisible College, of which Boyle was a member. This group met at Oxford and in London and from this arose the **Royal Society** (a scientific academy) in London in 1662.

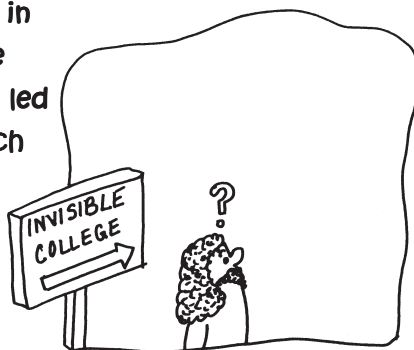

## Late 17<sup>th</sup> century

The attention of scientists was centred around understanding the nature of combustion and the forces that hold chemical compounds together.

While observing something burn, the flame seemed to be escaping from the object, so something seemed to be lost in the process. The relatively light ash left when an organic substance was consumed corroborated this. The practical metallurgists knew quite well that when metals were heated they were converted to a heavier powder, but they did not connect this to burning of organic substances.

Experiments showed that air was required for combustion. For example, Boyle tried to burn sulphur in a vacuum and failed. This proved that burning required air.



Joachim Becher (1635 – 1682) in

Germany felt that substances which could burn contained a fatty component called "terra pingus" and this left the substance during combustion.

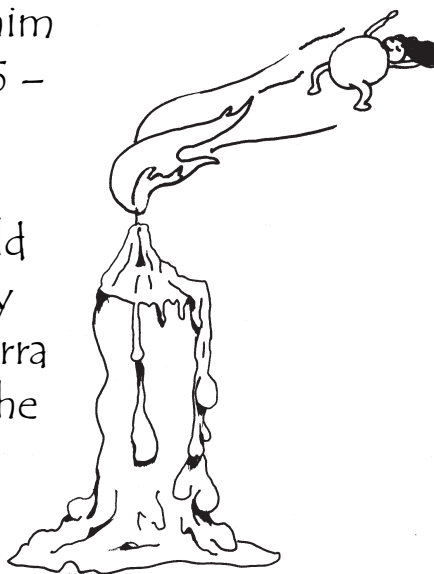

This idea was taken up by his pupil **Georg Ernst Stahl** (1660 – 1734), who further developed this idea and came up with a theory to explain the process of combustion. To the fatty earth, Stahl gave the name **phlogiston** from the Greek word for "burned" or "inflammable".



"When combustion occurs phlogiston is lost from the substance and air is essential as the medium to carry away the phlogiston. Metal when heated loses phlogiston and is converted to calx (oxide). The metal is therefore a more complex substance than the calx."



**“Plants absorb phlogiston from air and are rich in phlogiston. Plant substances can react with metal calces to restore the phlogiston and convert them to metals again. Charcoal is extremely rich in phlogiston and the most useful substance for this purpose.”**

Phlogiston theory supplied an excellent explanation for the then known facts about combustion. Oxidation-reduction was explained, though the explanation was essentially the reverse of what we think. So, for example, during oxidation, we consider a substance oxygen to be taken up. However, Stahl considered a substance phlogiston to be given off.



But, there was an apparent inconsistency. When organic substances burned, the product weighed less than the original substance. The problem arose with the calcination of metals. This was recognised as the same process, but the products weighed more than the original substance. To Stahl this was not important. He thought of phlogiston as a “principle” that could not be known directly, rather than a definite physical substance. This abstractness of thinking when faced with inconvenient facts would, in time, lead to the downfall of the phlogiston theory.

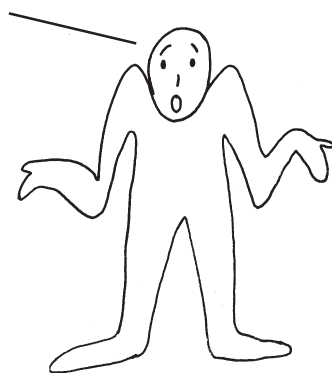

**But as of the mid-1700s, the phlogiston theory was almost completely accepted.**

Side by side, theories of **chemical affinity** – the “**force**” causing reactions – developed. Affinity was considered in terms of Newton's ideas (which were gaining wide acceptance at the time for explaining physical phenomena) that every particle of matter was endowed with a certain attractive force that uniquely caused all its chemical and physical reactions. To make the concept generally useful, chemists felt the need to draw up tables of affinity that would express the reactivity of individual compounds toward each other. They also hoped that such tables could be used to predict the reactivity of other compounds in similar reactions.

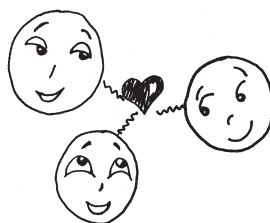

The table of **Etienne-Francois Geoffroy** (1672 – 1731) arranged substances in columns, with their respective alchemical symbols at the head of each column. The rest of the column listed substances that were **found by experiment** to react with the substance at the head. The arrangement was such that, the lower you go in each column, the lesser the affinity the substance had, for the one at the head. In other words, each column was arranged in a descending order of affinity for the substance at the head.

**TABLE DES DIFFERENTS RAPPORTS**  
*observez entre différentes substances.*

Mém. de L'Acad. 1738. Pl. II. pag. 212.

☿	♃	♄	♅	♆	♇	♈	♉	♊	♋	♌	♍	♎	♏	♐	♑	♒	♓
♃	♄	♅	♆	♇	♈	♉	♊	♋	♌	♍	♎	♏	♐	♑	♒	♓	♁
♄	♅	♆	♇	♈	♉	♊	♋	♌	♍	♎	♏	♐	♑	♒	♓	♁	♂
♅	♆	♇	♈	♉	♊	♋	♌	♍	♎	♏	♐	♑	♒	♓	♁	♂	♂
♆	♇	♈	♉	♊	♋	♌	♍	♎	♏	♐	♑	♒	♓	♁	♂	♂	♂
♇	♈	♉	♊	♋	♌	♍	♎	♏	♐	♑	♒	♓	♁	♂	♂	♂	♂
♈	♉	♊	♋	♌	♍	♎	♏	♐	♑	♒	♓	♁	♂	♂	♂	♂	♂
♉	♊	♋	♌	♍	♎	♏	♐	♑	♒	♓	♁	♂	♂	♂	♂	♂	♂
♊	♋	♌	♍	♎	♏	♐	♑	♒	♓	♁	♂	♂	♂	♂	♂	♂	♂
♋	♌	♍	♎	♏	♐	♑	♒	♓	♁	♂	♂	♂	♂	♂	♂	♂	♂
♌	♍	♎	♏	♐	♑	♒	♓	♁	♂	♂	♂	♂	♂	♂	♂	♂	♂
♍	♎	♏	♐	♑	♒	♓	♁	♂	♂	♂	♂	♂	♂	♂	♂	♂	♂
♎	♏	♐	♑	♒	♓	♁	♂	♂	♂	♂	♂	♂	♂	♂	♂	♂	♂
♏	♐	♑	♒	♓	♁	♂	♂	♂	♂	♂	♂	♂	♂	♂	♂	♂	♂
♐	♑	♒	♓	♁	♂	♂	♂	♂	♂	♂	♂	♂	♂	♂	♂	♂	♂
♑	♒	♓	♁	♂	♂	♂	♂	♂	♂	♂	♂	♂	♂	♂	♂	♂	♂
♒	♓	♁	♂	♂	♂	♂	♂	♂	♂	♂	♂	♂	♂	♂	♂	♂	♂
♓	♁	♂	♂	♂	♂	♂	♂	♂	♂	♂	♂	♂	♂	♂	♂	♂	♂
♁	♂	♂	♂	♂	♂	♂	♂	♂	♂	♂	♂	♂	♂	♂	♂	♂	♂
♂	♂	♂	♂	♂	♂	♂	♂	♂	♂	♂	♂	♂	♂	♂	♂	♂	♂
♂	♂	♂	♂	♂	♂	♂	♂	♂	♂	♂	♂	♂	♂	♂	♂	♂	♂

- ☿ Espris acides
- ♃ Acide du sel marin.
- ♄ Acide nitreux
- ♅ Acide vitriolique.
- ♆ Sel alcali fixe
- ♇ Sel alcali volatil

- ♆ Terre absorbante
- SM Substances metalliques
- ♃ Mercure
- ♅ Regule d'Antimoine.
- ♃ Or
- ♅ Argent

- ♃ Cuivre
- ♃ Fer
- ♃ Plomb.
- ♃ Etain.
- ♃ Zinc
- ♃ Pierre Calaminaire.

- ♃ Soufre mineral
- ♃ Principes huileux ou Soufres Principes
- ♃ Espris de vinaigre
- ♃ Eau.
- ♃ Sel.
- ♃ Espris de vins & Espris ardens

**Geoffroy's Table of Affinities. (From Mémoires de l'Académie royale des sciences, 1718, p. 212.)**

The compilation of these tables became more difficult as the number of known chemical compounds increased.



*Till now gases were thought to not take part in chemical reactions. The greatest advance in laboratory discoveries of the 18<sup>th</sup> century lay in the isolation and identification of gases as chemical individuals.*

An English clergyman **Stephen Hales** (1677 – 1761) investigated the amounts of "air" that were evolved from different substances by heating. In the course of this work he perfected the pneumatic trough to collect, over water, the gases that were formed. This apparatus was of great value to later workers in the field of gas chemistry.

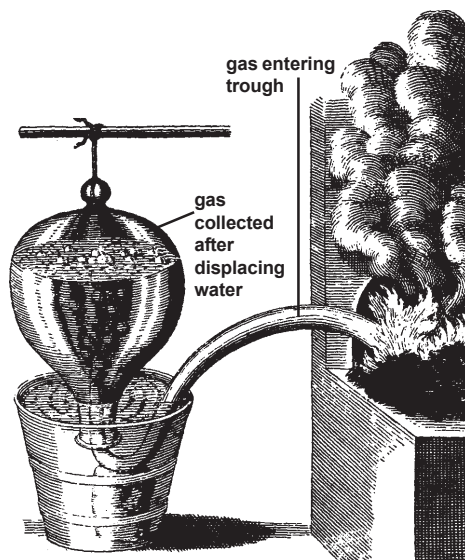

Hales's pneumatic trough

In Scotland, Joseph Black (1728 – 1799) conducted studies on gases which were part of his thesis for the Doctor of Medicine at the University of Edinburgh.

“A gas is lost on heating limestone ( $\text{CaCO}_3$ ) and it is converted to quicklime ( $\text{CaO}$ ).

Treatment of the quicklime with ‘alkali’ (sodium carbonate) gives the original limestone.”

“We have seen that a gas can react chemically. The gas ( $\text{CO}_2$ ) can be fixed in solid form so lets call it ‘fixed air’.”

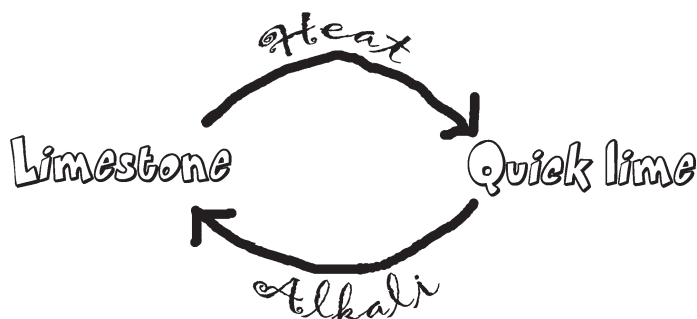

This work completely altered the thought of chemists. For the first time it was shown that a gas could combine chemically with a solid (be “fixed” by it) to produce a new compound with different properties, instead of being held by some indefinite physical force.

Dissenting English clergyman,  
**JOSEPH PRIESTLEY**

(1733 – 1804), was an amateur chemist. He was completely untrained in chemistry and did not begin chemical investigations till he was thirty eight years old. He happened to live next to a brewery from which he could obtain a large supply of carbon dioxide. This allowed him to study the gas and find that it extinguishes burning chips of wood.

Priestley used mercury instead of water in a pneumatic trough and he was thus able to isolate gases which until then could not be isolated (because they dissolve in water). Priestley was the first to isolate and characterise the gases nitric oxide, carbon monoxide, sulphur dioxide, hydrogen chloride and ammonia.

**A practical result of Priestley's studies with carbon dioxide was that in 1772, he invented soda water!**

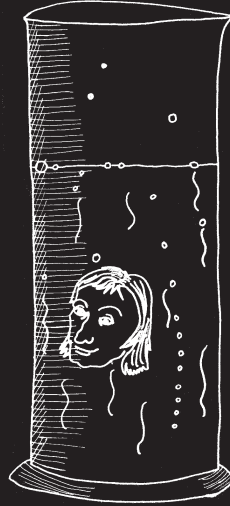

**1774**. By heating "red precipitate" (mercuric oxide though it was not known then), with a lens, he obtained a colourless odourless gas. A candle burned more brightly in the presence of the gas. Animals lived longer in a sealed jar

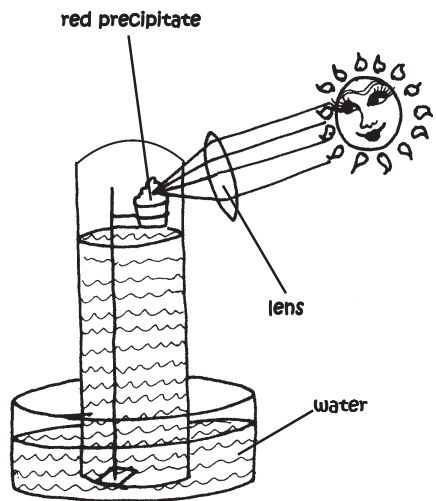

containing the gas  
than in a jar of  
atmospheric air.  
Priestley had  
discovered oxygen.

“This gas is  
‘dephlogisticated air’  
because it has a great  
capacity to absorb  
phlogiston released  
during combustion.”

This gas was independently discovered by another scientist CARL WILHELM SCHEELE (1742 – 1786).

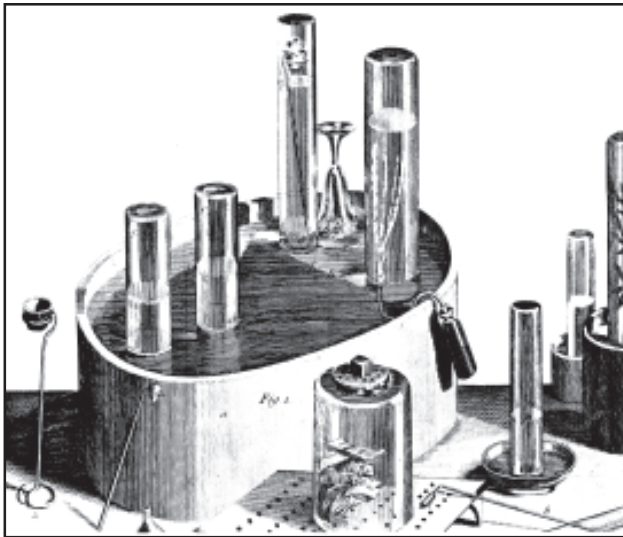

This image is reproduced from Priestley's book, *Experiments and Observations on Different Kinds of Air*. It shows Priestley's apparatus for experiments with gases; the large vessel is a pneumatic trough, and there are mice and plants in the inverted jars.

Priestley also  
discovered that green  
plants give off  
dephlogisticated air in light,  
which was the basis for all  
later studies in  
photosynthesis.

There was a large amount of experimental data available now which could not be explained by phlogiston theory.

**Antoine Laurent Lavoisier** (1743 – 1794), a wealthy Frenchman, came up with a theoretical framework for understanding combustion and other chemical reactions which placed chemistry on an essentially modern basis.

This step is often called the

## CHEMICAL REVOLUTION

“Calcination of metals is analogous to the burning of phosphorus and sulphur, and involves a combination with air.”



Antoine Laurent Lavoisier



1770s

He performed an experiment where tin was calcined in a sealed vessel where it was partly converted to calx (oxide), but there was no gain of weight until the vessel was opened. When this was done, air could be heard rushing in. There was no doubt that the increase in weight when a calx was formed came from a combination of the metal with air. Thus it was realized that the metal is a simpler substance than the calx unlike what was thought in the framework of the phlogiston theory.

"I found that air is a mixture of two substances – to the purer part, which is used in respiration and in calcinations of metals, we give the name oxygen and the residue we will call mofette. I later decided to call the residue azote, from the Greek term meaning 'without life'. In 1790, Jean Antoine Chaptal gave it its modern name, nitrogen."

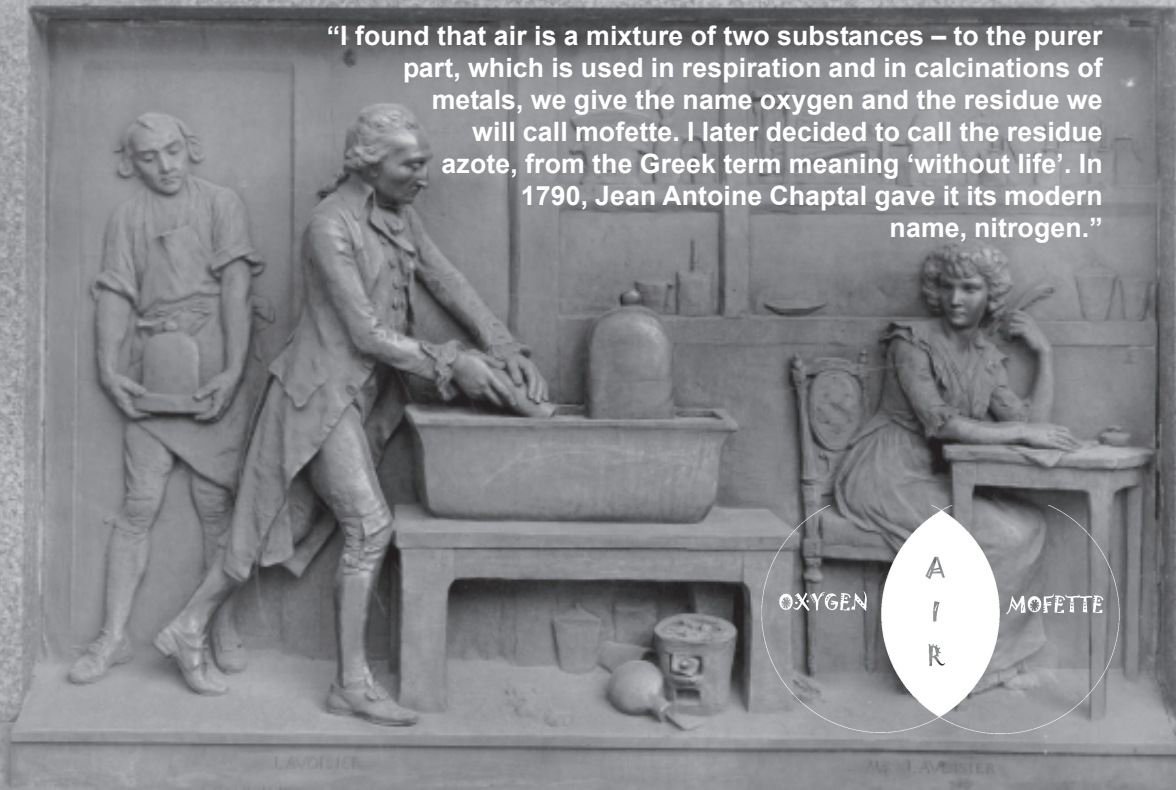

"Phlogiston theory has several weaknesses, which can be avoided if it is recognized that, in every combustion, combination with oxygen occurs, with evolution of heat and light."

The final step required for completing Lavoisier's theory was understanding the composition of **WATER**.

In 1781, Joseph Priestley and Henry Cavendish observed droplets condensing in the vessels in which "inflammable air" (hydrogen) burned. These droplets were shown to be water. A couple of years later, Lavoisier came up with an explanation for this...

"Water is a compound of inflammable air (the name for hydrogen given by its discoverer Cavendish) and oxygen."

**1789, Paris:** A textbook of chemistry by Lavoisier, **Traité élémentaire de chimie** was published, which rejected through experiments, the phlogiston theory and provided the new, essentially modern explanation for combustion. The book also contained a "table of simple substances belonging to all kingdoms of nature, which may be considered the elements of various bodies in nature". This is considered the first true table of chemical elements.

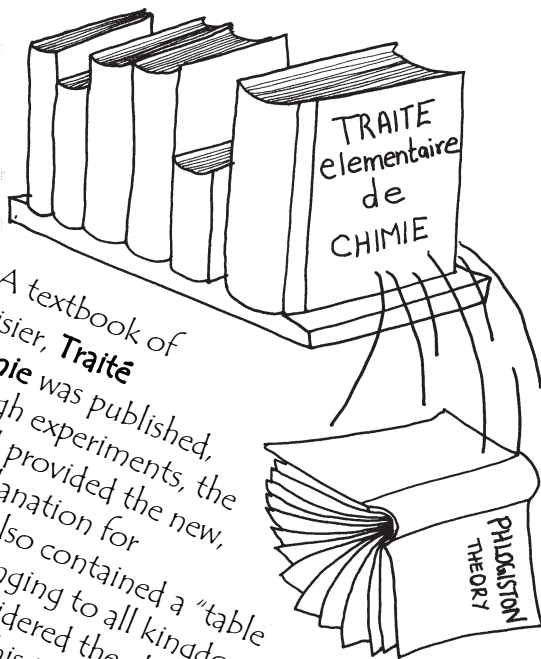

The book also represents the fermentation process in the following way:

**must of grapes = carbonic acid + alcohol**

This is the forerunner of a modern chemical equation.

Lavoisier at the age of fifty was guillotined in 1794 during the frenzy of the French Revolution.

In ~~1799~~ French chemist Joseph **LOUIS PROUST** (1754 – 1826) who taught at Madrid demonstrated practically the law of constant proportions: He showed that, in copper carbonate, the proportions by weight of the elements that constitute it, are fixed, no matter how it is prepared and whether it occurs naturally or is prepared by synthesis.



In Manchester,  
**John Dalton** (1766 – 1844)  
developed an atomic theory which would explain the observations of Proust and provide a basis for considering compounds the way we do today.

**“Atoms are dense spheres and are of different sizes for different substances. A compound of two substances (a binary compound) contains one atom of each of the two constituents. Water is a compound of one atom of hydrogen and one of oxygen, ammonia one of hydrogen and one of nitrogen and so on.”**



John Dalton



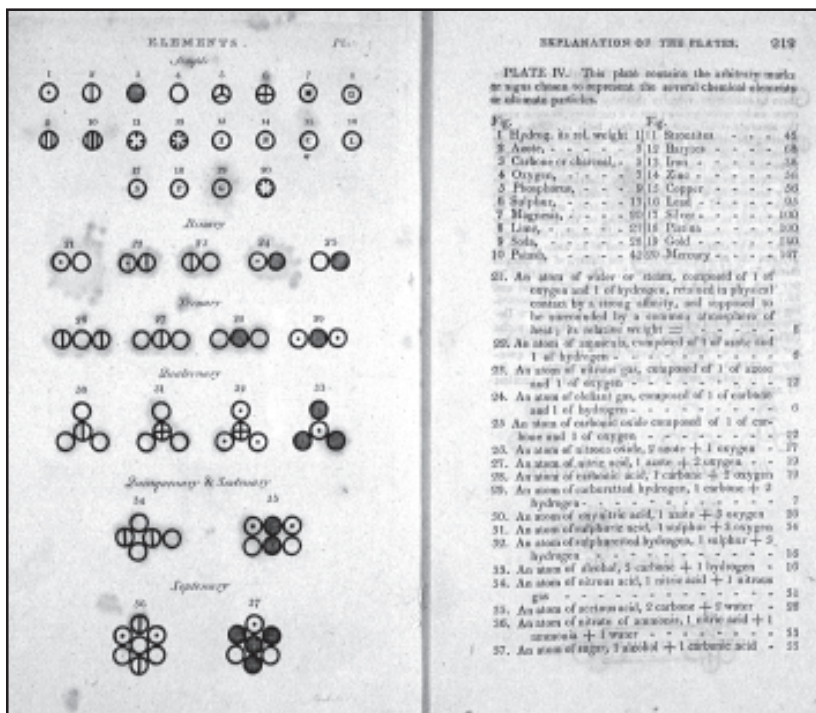

Pages from Dalton's book *A New System of Chemical Philosophy*

Based on this assumption, after chemical analysis of compounds, Dalton obtained relative weights of atoms. The analysis of water available to him showed that it contained  $85 \frac{2}{3}$  parts of oxygen and  $14 \frac{1}{3}$  parts hydrogen. If the relative weight of hydrogen was taken as unity, the relative weight of oxygen became 6. In a similar way, Dalton came up with relative weights of other atoms and drew up the first table of atomic weights.

Dalton devised a set of symbols to express his theory. The graphic nature of the theory helped in its acceptance.

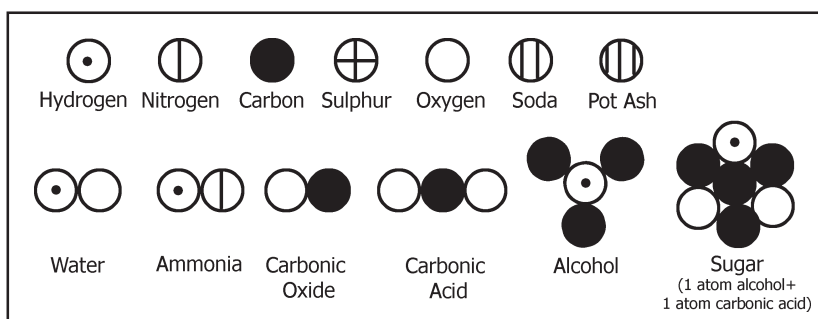



Swedish chemist, **Jöns Jacob Berzelius** (1779 – 1848) recognized that in a compound one atom of an element might combine with varying numbers of atoms of other elements, and that two atoms could combine with multiple numbers of other atoms.

**1809**. French chemist, **Joseph Louis**

**Gay-Lussac** (1778 – 1850) proposed, “The ratios of the volumes of reacting gases are small whole numbers – hydrogen and oxygen unite in the proportions 2:1 to form water, 1 volume of nitrogen and 3 of hydrogen combine to form ammonia.”

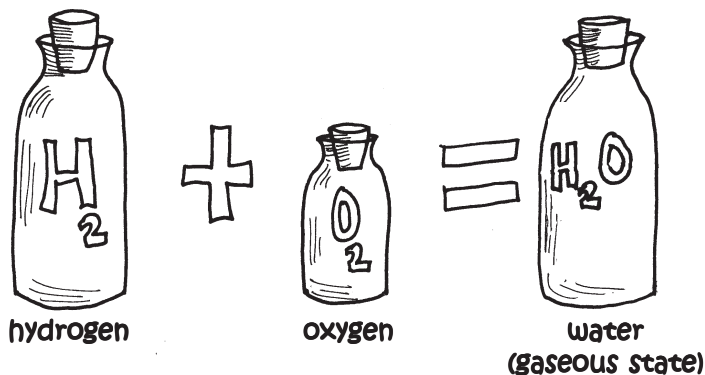

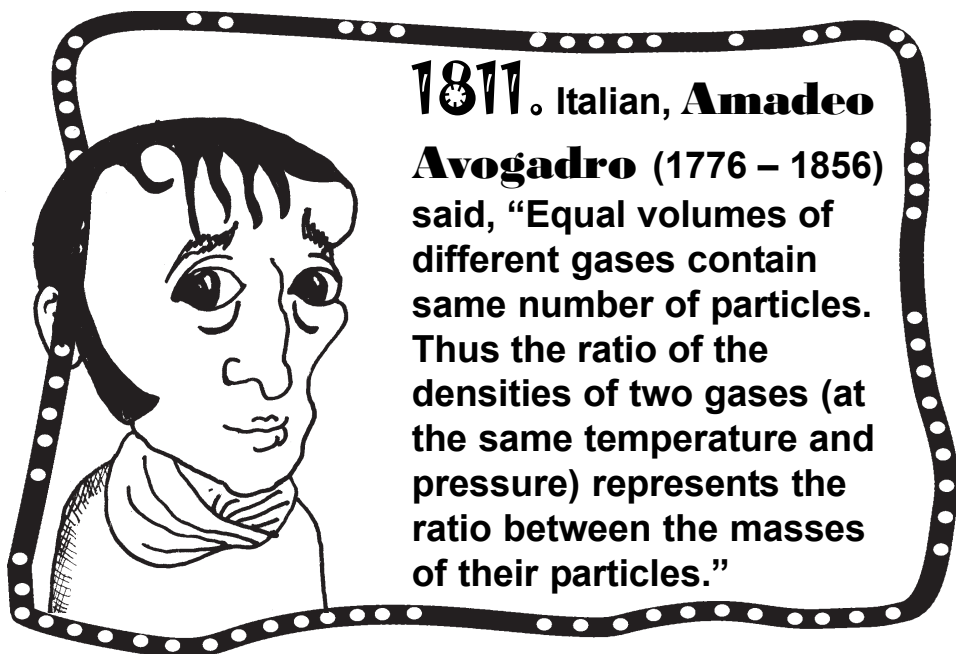

Avogadro assumed that atoms of a simple gas could combine with each other to form a molecule (like  $O_2$ ,  $H_2$ ) and in reaction with another gas, these molecules could split apart to form new molecules. “The molecule of water will be comprised of half a molecule of oxygen with one molecule, or two half molecules of hydrogen”.

It was hard for scientists to conceive of two like atoms uniting and there were not enough facts confirming Avogadro’s hypothesis, so there was half a century of confusion before it was finally accepted.



**1814.** Berzelius drew up a table of atomic weights that is very close to that used today. The fact that numerical calculations could be applied to chemical equations and that each element was recognized as having certain fundamental characteristics greatly systematized chemistry.

The systematization became more pronounced when Berzelius introduced **modern chemical symbols**, which was a convenient shorthand to represent compounds. The initial letter of the Latin name of the element was used and when names began with the same letter, the next distinctive letter of the name was to be added. A symbol represented one atom or **atomic weight** of the element.

Element	Latin name	Symbol
Sulphur	Sulphur	S
Silicon	Silicium	Si
Antimony	Stibium	St *
Tin	Stannum	Sn

\* Some modifications have been made to Berzelius's symbols. Antimony is a case, whose present symbol is Sb.

A new direction for scientific exploration opened up around this time due to the discovery of electricity from chemical reaction.

The way to generate electricity known at the time was by rubbing together certain materials. The discovery of chemical electricity happened by chance.

In **1786**, **Luigi**

**Galvani** (1737 – 1798), professor of anatomy at the University of Bologna hung a dissected frog muscle on a copper hook placed on an iron support. The muscle twitched. Galvani sought an explanation for this interesting phenomenon. Being a biologist, he centred his attention on the muscle. He thought electricity arose in the muscle causing it to twitch.

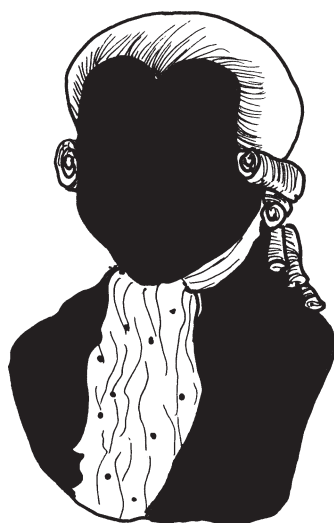

Luigi Galvani

I remember getting an electric shock from an eel. Animals do produce electricity!

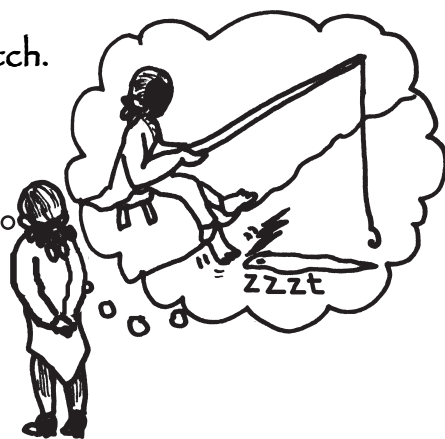

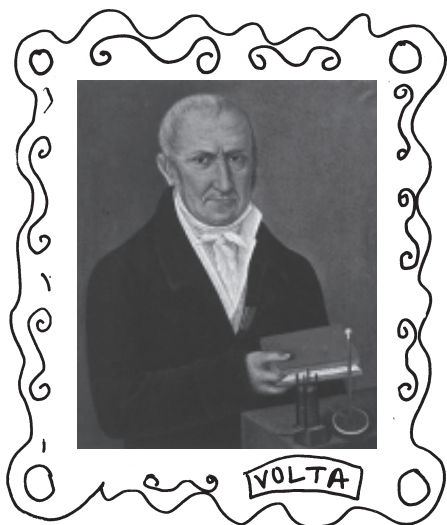

Fellow countryman,  
**ALESSANDRO VOLTA**  
(1745 – 1827) thought,

“Maybe it is  
the contact of  
different metals in a  
moist environment  
that causes the  
electricity and the  
muscle is only an  
indicator.”

Volta performed an experiment where he arranged silver and zinc plates separated by cloth soaked in brine. He found that this produced electricity and the effect increased with more such junctions.

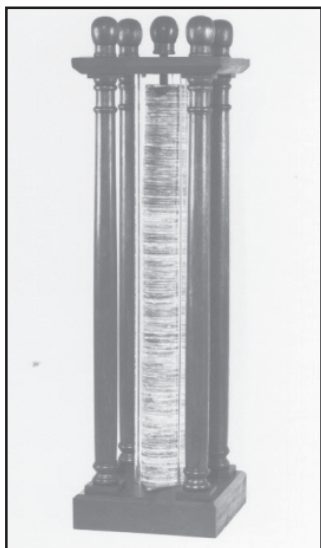

A Voltaic pile

The **VOLTAIC PILE** was the first true battery, and from it came a continuous current whose effects could be increased by merely increasing the size and number of alternating plates. Almost at once chemists began to use this new apparatus to produce chemical reactions.

**HUMPHRY DAVY** (1778 – 1819), a professor of chemistry at the Royal Institution in London, constructed a battery of over 250 metallic plates. In **1807**, using electricity from this battery, he was able to extract highly reactive metals like potassium and sodium by electrolysis of fused salts.

Davy made several other important contributions to science including designing a lamp which was safe for miners to use in methane rich atmospheres (methane is highly inflammable).



Davy's safety lamp

Davy had chosen Michael Faraday (1791-1867) as his assistant while at the Royal Institution. This is a famous conversation between Davy and a journalist:

Mr. Davy,  
what is your  
greatest  
discovery?



My greatest  
discovery is  
**Michael  
Faraday!**

Michael Faraday's father was a blacksmith and could not afford to give him a formal education. Faraday worked with a bookbinder. This job gave him two things – a large variety of books to read and a training in using tools with precision and dexterity. His deep interest in science got him in contact with Davy where he flourished as a scientist.

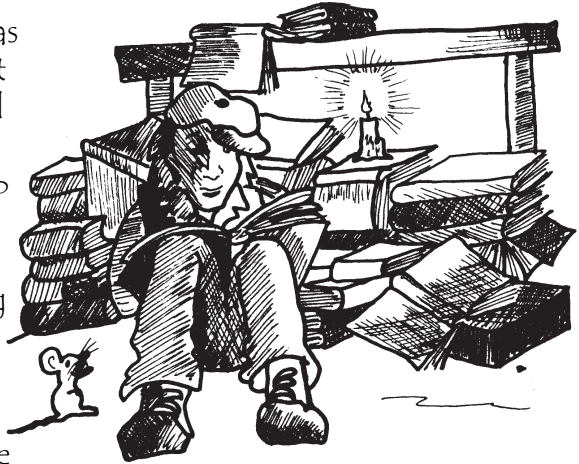

**1833.**



In electrolysis the amount of substance decomposed is proportional to current strength and time, and the weight of substance decomposed is proportional to the equivalent weight of the substance.



Since electrolysis broke up chemical compounds, it was assumed that electricity was concerned in some way with affinity, an idea that had preoccupied chemists. Berzelius assumed that every atom has different degrees of excess positive or negative charge. When compounds are formed there is a neutralization of charges, but the resulting compound is not necessarily neutral since the charges on the two reactant atoms are unequal and don't neutralize each other exactly.

For example, sulphur, electropositive with respect to oxygen, could combine with it to form the binary compound sulphur trioxide,  $\text{SO}_3$ , in which the negative charge predominates, leaving the compound as a whole electrically negative. Similarly, potassium and oxygen combined to give the oxide  $\text{K}_2\text{O}$ , which retains positive charge. Therefore the oxides of sulphur and potassium could combine to form the salt potassium sulphate.

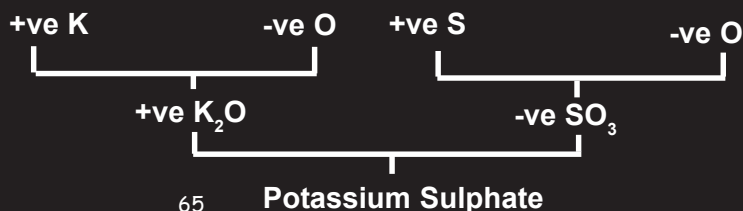

This theory fit the facts of electrolysis well and gave an explanation of the forces of affinity that held salts together. However, it went against some experimental facts, for example that the actual compounds  $\text{SO}_3$  and  $\text{K}_2\text{O}$  were not electrically charged. It also had some other defects, like it made it impossible to accept Avagadro's theory in which two similarly charged atoms of hydrogen, oxygen or nitrogen were united with each other. This difficulty would become more evident with later developments of organic chemistry and was a chief factor in its downfall.

The theory was not generally applicable, but it did well to explain the interaction of acids, bases and salts, and is still essentially a part of our explanation of the nature of ionic compounds.

**At this time, chemistry for the first time was fully recognized as a profession in its own right. Professors of chemistry became more common in universities. Earlier, chemists were often trained as pharmacists or physicians before they undertook chemical investigations.**



The international character of science and free exchange of ideas helped greatly in its growth. A great example of this is the fact that in 1813 Davy was able to visit France and travel through the laboratories as a guest of French chemists, though England and France were in the midst of the Napoleonic wars.



Let us now look at the development of

## ORGANIC CHEMISTRY.

Hello, we are the Organic family! And we share great organic chemistry with the Halogen family!

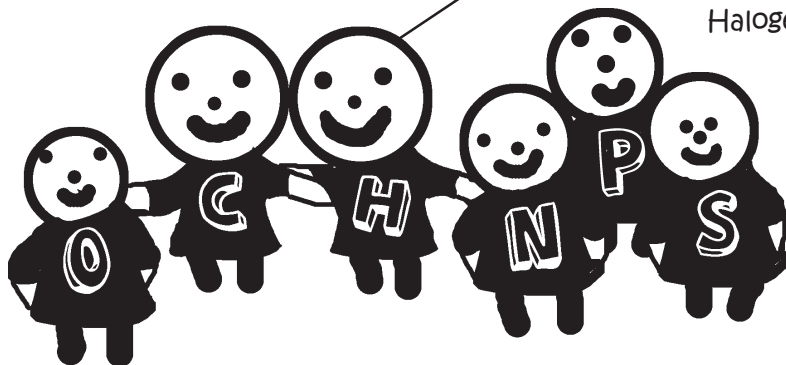

The products of a living organism, organic compounds, were thought to be controlled by a special "vital force" exerted by life itself that gave distinctive properties to organic compounds. This view of Berzelius and most other scientists, was challenged when in 1828 German chemist **Friedrich Wöhler** (1800 – 1882) **synthesised urea**, a typical product of the animal body, by evaporating an aqueous solution of ammonium cyanate, an inorganic salt.



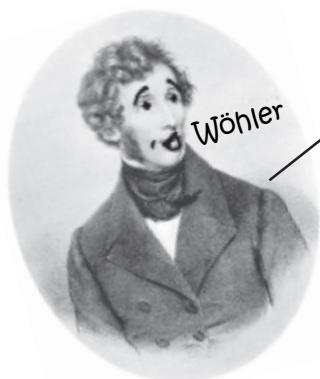

Wöhler

Most fascinating!  
Urea without a  
kidney!

Wöhler's discovery refuted the Vital force theory. In a letter to Berzelius, whom he had been associated with, Wöhler wrote, "I must tell you that I can prepare urea without requiring the kidney of an animal, either man or dog".

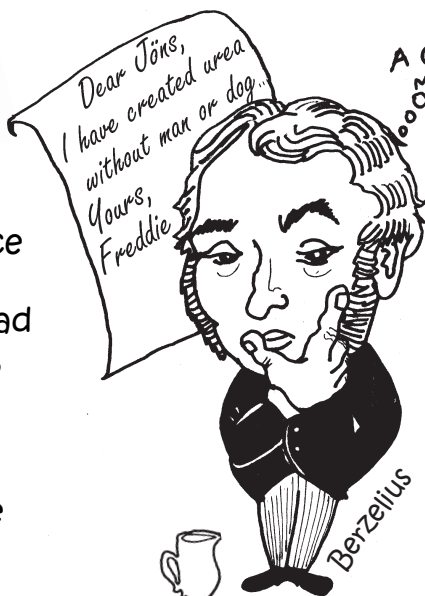

A COW  
MAYBE?

Berzelius

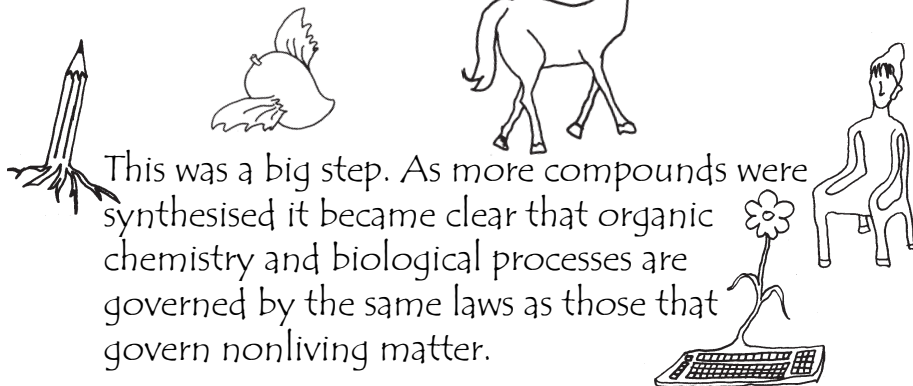

This was a big step. As more compounds were synthesised it became clear that organic chemistry and biological processes are governed by the same laws as those that govern nonliving matter.

A great interest arose in synthesising organic compounds from nonliving substances, like coal tar and petroleum, and eventually, led to the boom in German academic and industrial organic chemistry in the second half of the 1800s.

## Justus Liebig (1803 – 1873)

contributed greatly to analytical organic chemistry. He developed a method by which the numbers of each type of atoms in a molecule could be obtained. He burned a weighed sample of organic substance and trapped the gases formed (chiefly carbon dioxide and water) with appropriate chemicals. From the increase of weight of the chemicals he could see how much weight had been added by the trapped products and from this he could determine the amount of carbon, hydrogen and oxygen in the original substance.

*Liebig went on a long carbon dioxide chase. He finally tracked it down and trapped it in this apparatus which was filled with a solution of caustic potash!*

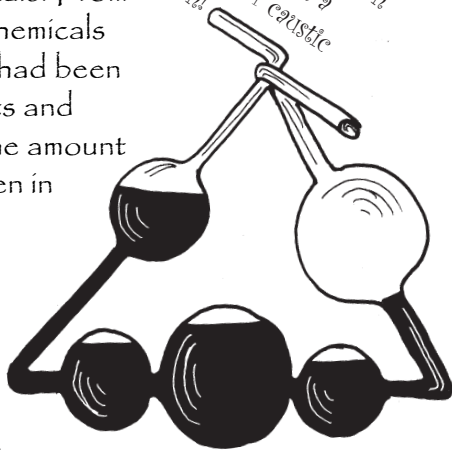

The concept of a **FUNCTIONAL GROUP**, a group of atoms that react as a unit, developed as a key idea in understanding organic chemistry. At the time, however, these groups were known as '**RADICALS**'. Chemists discovered that radicals give compounds some of their properties. Compounds were classified as hydrocarbons or 'fundamental radicals', acids, alcohols, etc.

Radicals of the world unite! We have nothing to lose but our bonds!

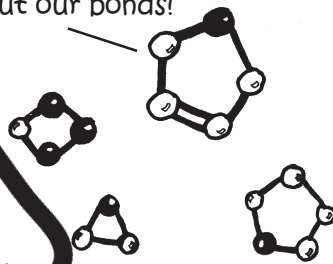

Those radicals are always forming groups! Say they want to change the world...

**1837. J. B. A. DUMAS** (1800 – 1884) and **Justus Liebig** said, "Radicals are the elements of organic chemistry. In mineral chemistry the radicals are simple while in organic chemistry the radicals are compounds; that is all the difference. The laws of combination and of reaction are otherwise the same."

In the 1850s, the work of several chemists culminated in the development of the idea of **MOLECULAR STRUCTURE**.

**1852. EDWARD FRANKLAND** (1825 – 1899) found that in case of nitrogen, phosphorus and arsenic, an atom of these elements always combined with three or five organic radicals. Zinc, mercury and oxygen combined with two.

Frankland said, "The combining power\* of the attracting element is always satisfied by the same number of uniting atoms, no matter what the character of the atoms is. It is like every atom has a certain number of hooks by which it attaches to other atoms or radicals."

\* The term combining power was variously expressed by other scientists as atomicity or affinity units or valence.

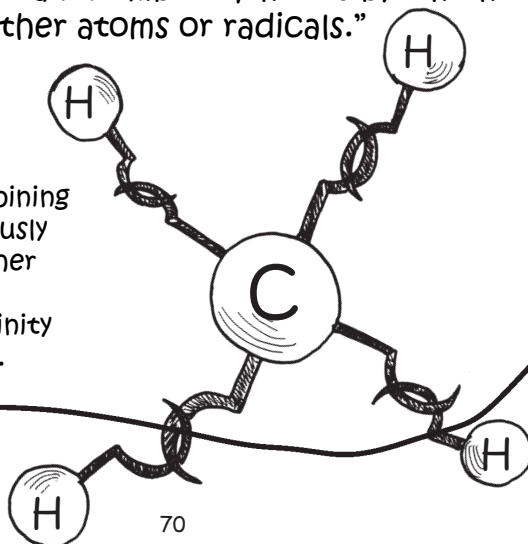

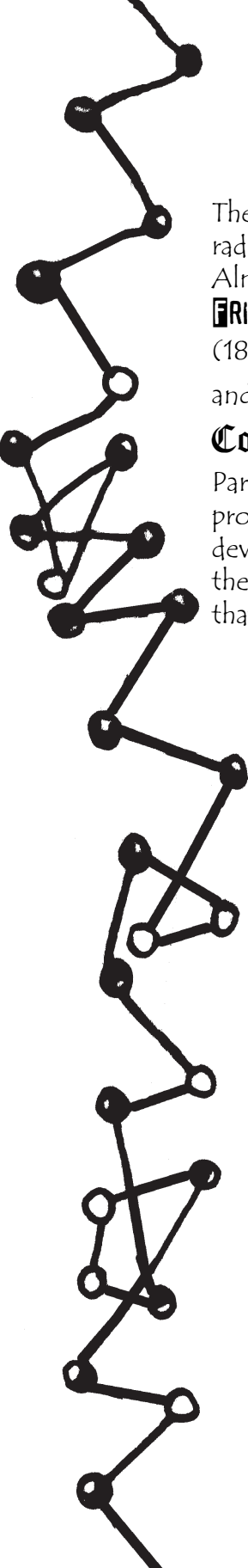

The inner constitution of the radicals was now considered. Almost simultaneously, **FRIEDRICH AUGUST KEKULE** (1829 – 1896) in Germany and **Archibald Scott Couper** (1831 – 1892) in Paris approached this problem independently and developed the key idea in the theory of organic chemistry – that of **structural formulas**.



**1858.**

Carbon is 'tetratomic', that is has four 'affinity units' by which it can unite with four monatomic elements like hydrogen and two diatomic elements like oxygen. Carbon can also use one of its affinity units to unite with another carbon atom and in this way chains of carbon atoms could be built up.

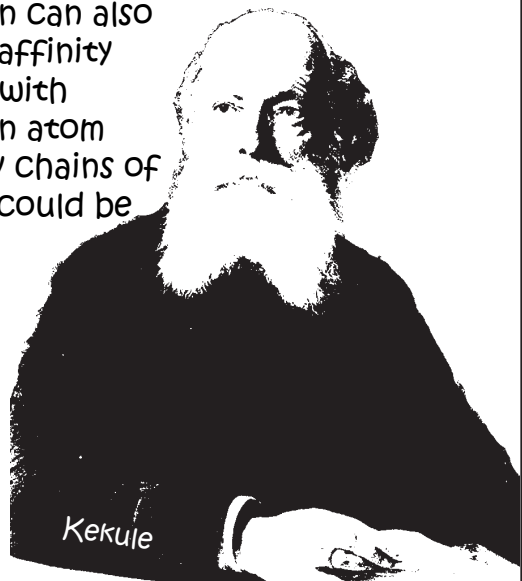

Kekule



Organic compounds can be represented by diagrams.

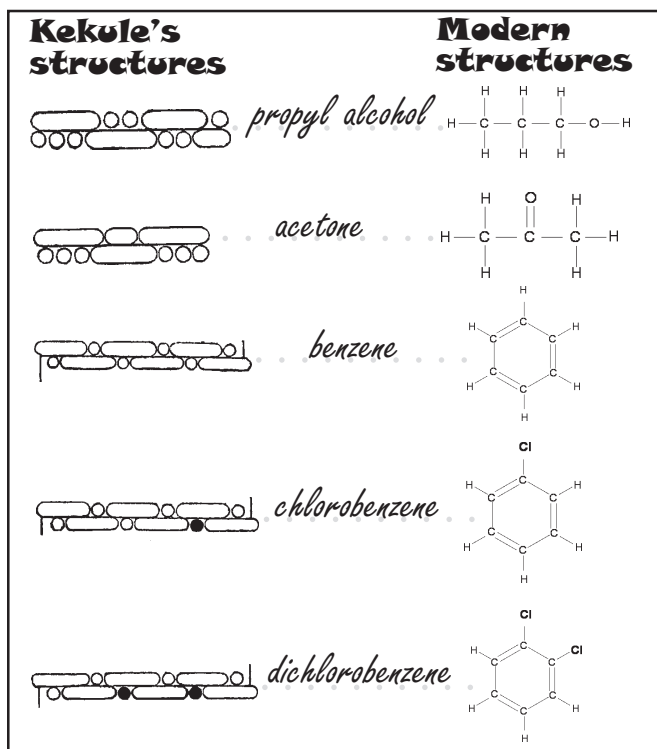

Kekule's diagrams were not very convenient for visualization of the actual structure. Couper developed the same theory as Kekule, but expressed the links between the atoms by lines thus giving the modern structural formulas.

The nature of most compounds could be understood, but the structure of aromatic compounds like benzene remained a mystery.

**1865.** Kekule was thinking hard about

this. The story goes that he dreamt of a snake forming a circle by biting its own tail. The image inspired him to picture a carbon chain bending and uniting with itself to form a ring. From this he deduced the structure of benzene. His remarkable ability of visualizing the structure of carbon skeletons in organic compounds was perhaps due to his early training in architecture.

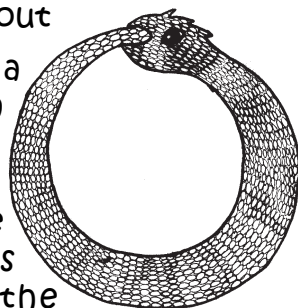



The structure of carbon compounds was extended by **Jacobus Henricus van't Hoff**

(1852 – 1911) and **J. A. Le Bel** (1847 – 1930) who pictured the valence bonds of carbon, not just in a 2-dimensional plane but directed uniformly in 3-dimensional space. Thus the carbon atom was at the centre of a tetrahedron with the bonds directed along the corners of the tetrahedron.

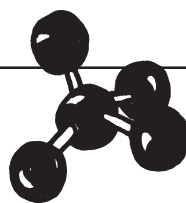

This could explain **stereoisomerism** – two compounds having the same atoms and atomic connectivity but different orientation of the atoms in space – a phenomenon studied

by **LOUIS PASTEUR**

(1822 – 1895) in 1848.

Pasteur noted that solid sodium ammonium tartrate existed as a mixture of two types of crystals, which he painstakingly separated with tweezers. When plane-polarized light passed through separate solutions of these two types of crystals, the plane of the light rotated in exactly opposite directions.

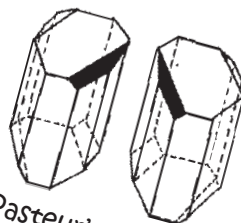
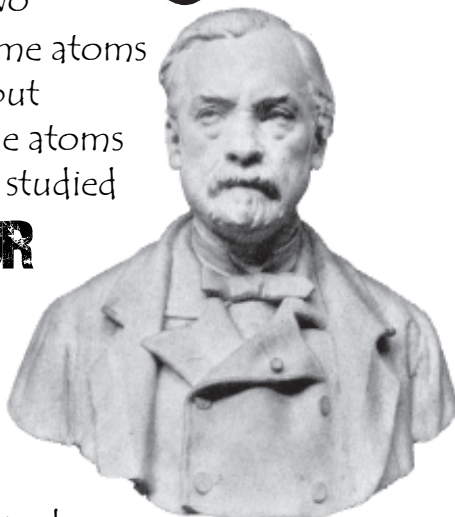

Pasteur's crystals

Several new elements were discovered in the 19<sup>th</sup> century. This was facilitated by the introduction of spectroscopic analysis.

Scientists had observed that sodium and potassium salts produce characteristic colours in a flame.

**ROBERT BUNSEN** (1811 – 1899) and **GUSTAV ROBERT KIRCHHOFF** (1824 – 1887) in 1859 built a new instrument, a **spectroscope** to study the light emitted by elements when in a flame. The spectroscope mapped the different frequencies of the emitted light.

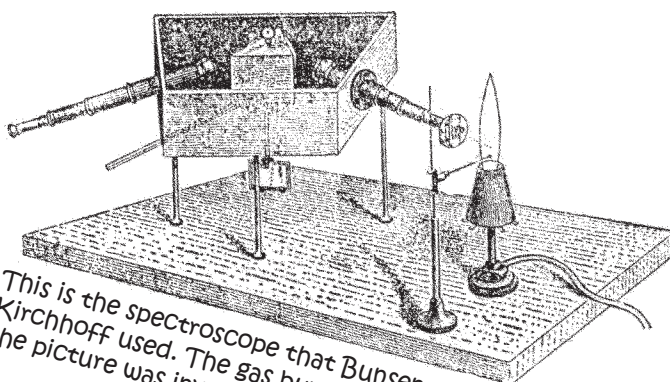

*This is the spectroscope that Bunsen and Kirchhoff used. The gas burner shown in the picture was invented by Bunsen in 1856.*

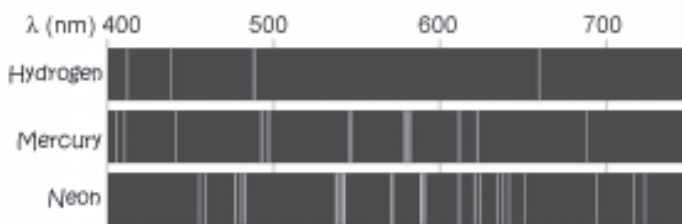

Atomic emission spectra of a few elements.  
Note that each element has different lines from the other.

Each element emits characteristic frequencies of light or lines in the spectrum and these are not affected by the presence of other elements.



Bunsen



Kirchhoff

Minute traces of an element are sufficient to give its characteristic spectrum or fingerprint. If there are lines in the spectrum we have not seen before, they must belong to a new element.

*Spectroscopic analysis was an extremely sensitive technique and led to the discovery of several elements. The earliest of these were caesium (caesius is sky blue in Latin) in 1860 and rubidium in 1861, which were named because of the beautiful blue and red lines in their respective spectra.*

As more elements became known, certain trends were recognised. Elements could be organised into groups based on the analogous properties and reactions of their members. The halogens and the alkali metals showed these analogies clearly. At the same time, the atomic weights determined by Berzelius gave a set of numerical values in terms of which some classification might be sought.

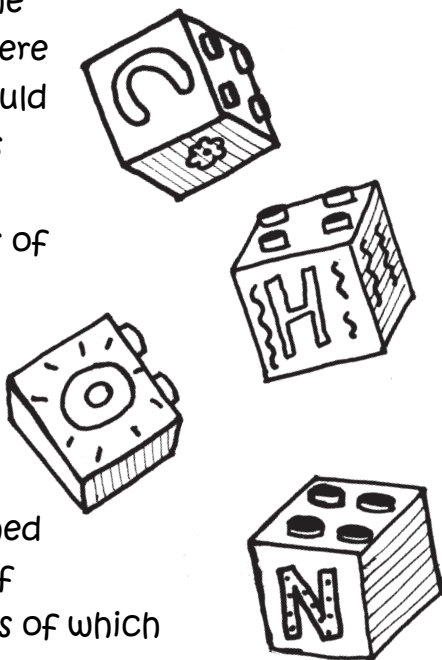

**1869**. **LOTHAR MEYER** (1830 – 1935) in Germany and **Dmitri Ivanovich Mendeleev** (1834 – 1907) in Russia simultaneously observed:



Meyer

"If we arrange the elements in the order of increasing atomic weight, a periodic recurrence of properties, physical and chemical can be noted."

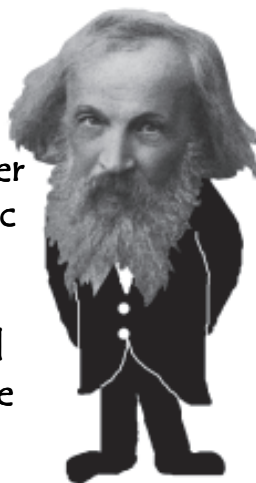

Mendeleev

They left vacant spaces where an element should fit into a family group but where such an element was not yet known.

**“The table can predict the chemical and physical properties of the elements that should occupy the vacant places in the table!”**

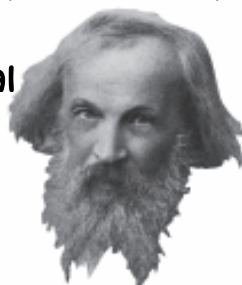

			Ti = 50	Zr = 90	? = 180
			V = 51	Nb = 94	Ta = 182
			Cr = 52	Mo = 96	W = 186
			Mn = 55	Rh = 104,4	Pt = 197,4
			Fe = 56	Ru = 104,4	Ir = 198
		Ni =	Co = 59	Pd = 106,6	Os = 199
			Cu = 63,4	Ag = 108	Hg = 200
H = 1			Zn = 65,2	Cd = 112	
	Be = 9,4	Mg = 24	? = 68	Ur = 116	Au = 197?
	B = 11	Al = 27,4	? = 70	Sn = 118	
	C = 12	Si = 28	As = 75	Sb = 122	Bi = 210?
	N = 14	P = 31	Se = 79,4	Te = 128?	
	O = 16	S = 32	Br = 80	J = 127	
	F = 19	Cl = 35,5	Rb = 85,4	Cs = 133	Tl = 204
Li = 7	Na = 23	K = 39	Sr = 87,6	Ba = 137	Pb = 207
		Ca = 40	Ce = 92		
		? = 45	La = 94		
		?Er = 56	Di = 95		
		?Yt = 60	Th = 118?		
		?In = 75,6			

**First form of Mendeleev's periodic table, 1869**

The elements gallium, germanium and scandium were unknown at the time and Mendeleev left spaces for them in his table and even predicted their atomic masses and chemical properties.

Predicted	Observed
Eka-aluminium	Gallium
Atomic weight: about 68	Atomic weight: 69.9
Metal of specific gravity 5.9; melting point low; non-volatile; unaffected by air; should decompose steam at red heat; should dissolve slowly in acids and alkalis. Oxide formula $Ea_2O_3$ ; should dissolve in acids to form salts of the type $EaX_3$ ; the hydroxide should dissolve in acids and alkalis.	Metal of specific gravity 5.94; melting point 30°C; non-volatile at moderate temperatures; not changed by air; no reaction with steam; dissolves slowly in acids and alkalis. Oxide formula $Ga_2O_3$ ; dissolves in acids to form salts of the type $GaX_3$ ; the hydroxide dissolves in acids and alkalis.

In 1874, gallium was discovered and Mendeleev's predictions were found to be accurate.

Other discoveries followed and their chemical behaviour matched that predicted by him. These led to the acceptance of the periodic table and it contributed greatly in systematizing inorganic chemistry.

In parallel to inorganic and organic chemistry, physical chemistry developed greatly in the nineteenth century. The three major fields of progress were chemical kinetics, thermodynamics and electrochemistry.

"Hi! I am the Chem-monster of the 19<sup>th</sup> century... My heads represent the different branches of chemistry in my time."

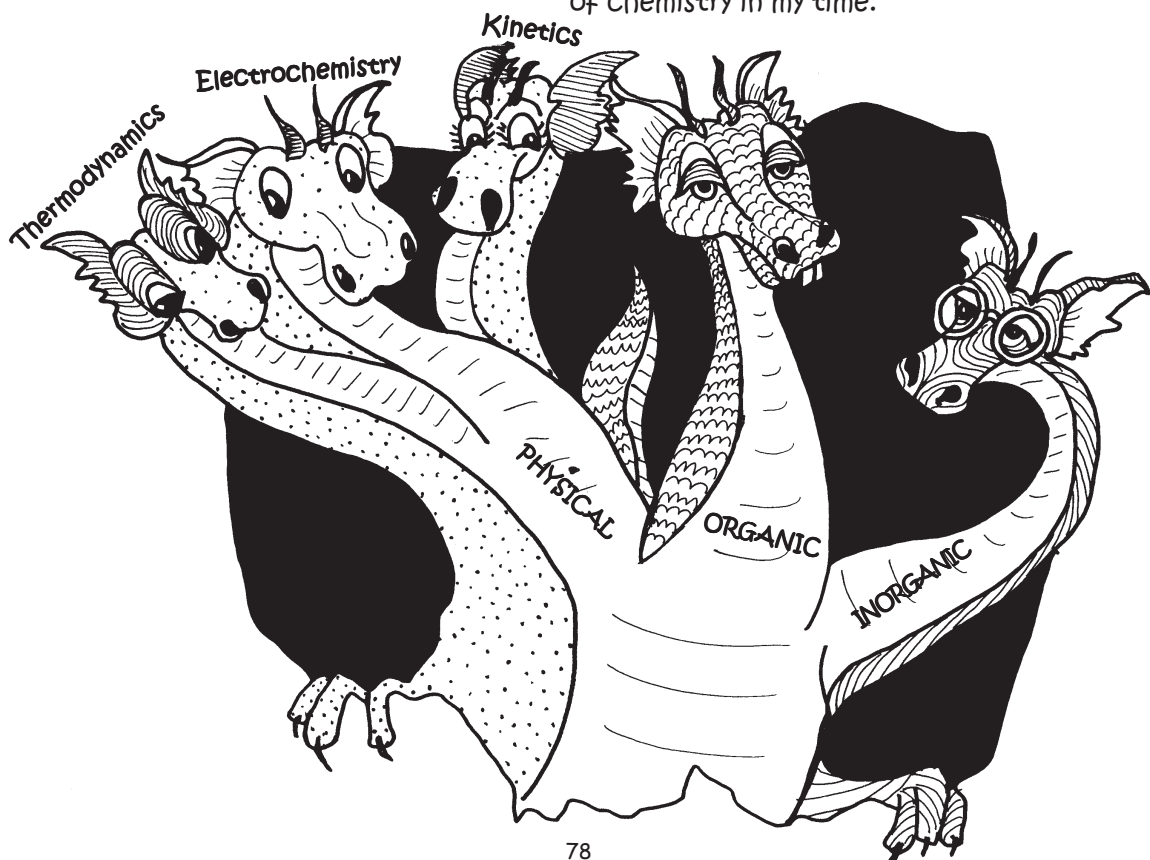

**1850.** **Ludwig Wilhelmy** (1812 – 1864)

studied the hydrolysis of cane sugar in the presence of acids. He used the change in optical rotation to know the sugar concentration, and **for the first time came up with a mathematical expression for a chemical process.**

Wilhelmy showed that: If  $Z$  represented the concentration of sugar, the sugar loss ( $dZ$ ) in the time interval  $dT$  is given by the expression

$$-dZ/dT = kZ$$

where  $k$  is a constant. **This is the rate expression for a monomolecular reaction.**

Around the same time, **A. W. Williamson** (1824 – 1904) had seen that when a reaction produces substances at a definite rate, and when these substances in turn react at a definite rate to regenerate the starting

materials, a time must come when a balanced equilibrium is reached. This was the concept of **dynamic equilibrium.**

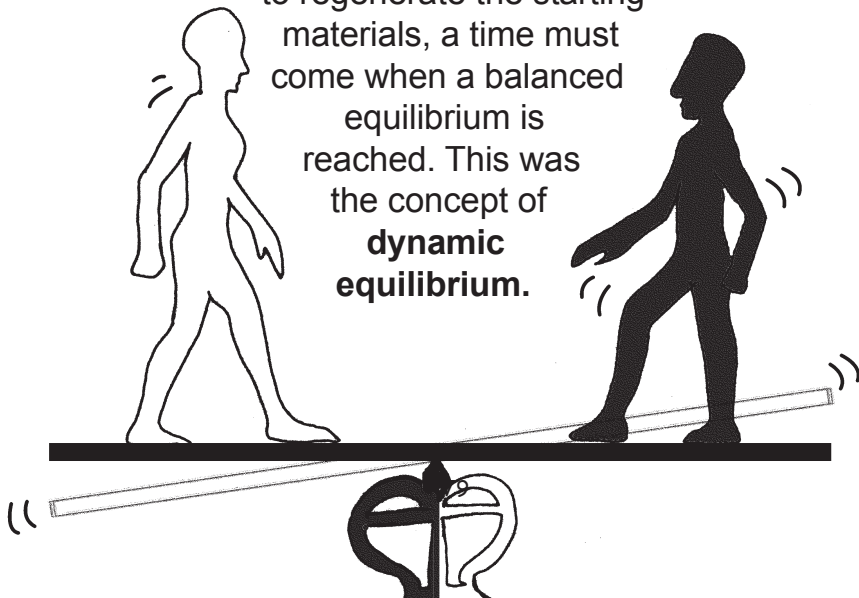

**1877**. **Van't Hoff** defined orders of reactions (first order, second order etc.) by classifying them according to the number of molecules taking part.

**Svante Arrhenius** (1859 – 1927) found,

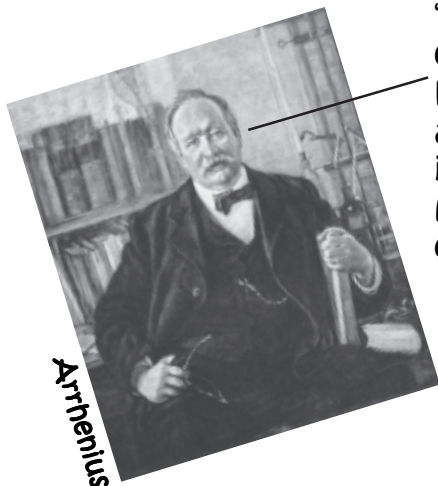

“Not every molecular collision in a mixture leads to reaction. Only active molecules, that is, the ones having a minimum activation energy, will react.”

On the basis of these ideas, **kinetics**, that is studies concerning reaction rates, became a recognized branch of chemistry. It contributed greatly to an understanding of the actual course of chemical reactions.



Several examples of Catalysis had been made by this time but the explanation remained **MYSTERIOUS**. There was speculation that a **catalytic force** changed the energy states of the molecules.



**1894.** **Wilhelm Ostwald** (1853 – 1932) gave

the modern view of a catalyst and related this phenomenon to the field of kinetics: A catalyst is a substance that increases reaction rates without altering the energy of the reactants and products, of a chemical process. A catalyst works by providing a pathway for the reaction having a lower activation energy, thus allowing a larger fraction of molecular collisions to lead to reaction.

Let us consider a situation to understand the role of a catalyst: Imagine you are in the middle of a desert and want to write on a piece of paper.

You can only keep it on the sand for support, but this would be a slow, difficult process.



However, if you had a clipboard to support the paper, the process will become much faster. After you have written on one sheet, you can use the clipboard again for another sheet.



So, the clipboard is like a Catalyst - it speeds up your writing without itself changing.

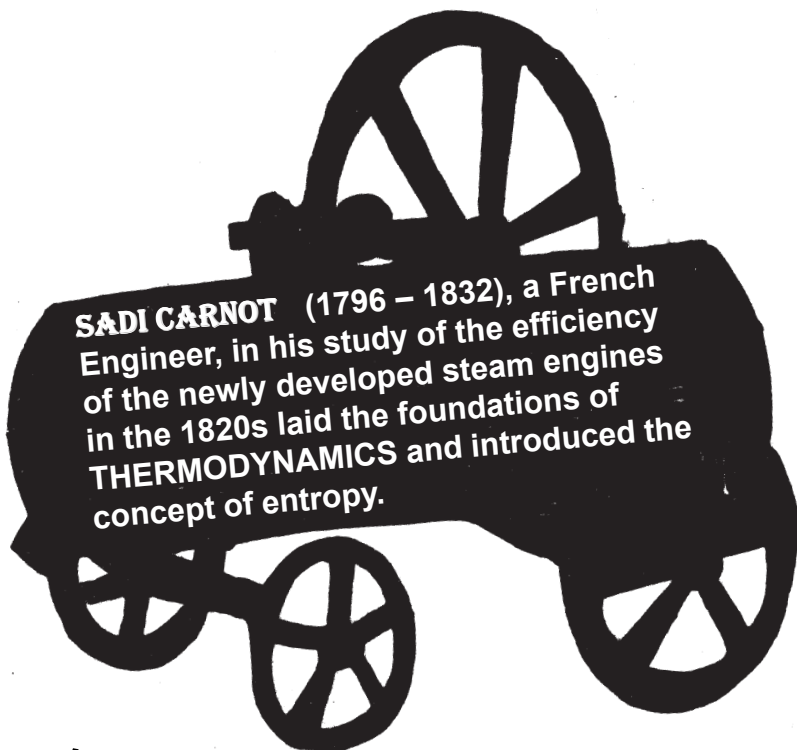

**1842.** German physician **ROBERT MAYER** (1814 – 1887), was impressed by the darker red colour of venous blood in the tropics, as compared to cold climates. The darker colour meant that there was more oxygen in the blood returning to the heart. From this Mayer inferred that, in hot climates, the body burned less (because it required less energy) to maintain body temperature. This was the first step towards the **law of conservation of energy**, which Rudolf Clausius would later arrive at.

**1845.** **James Prescott**

**Joule** (1818 – 1889) observed that churning a liquid increased its temperature and from this showed the equivalence of heat and mechanical energy.

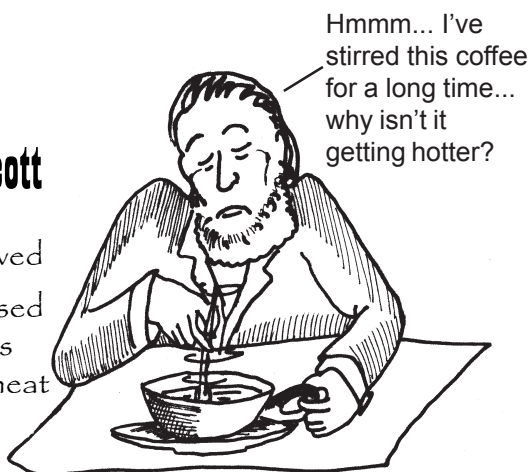

# Rudolf Clausius (1822 – 1888) in 1865

suggested the name **ENTROPY** for a new thermodynamic state function and offered his well known summary of the two laws:



1. The energy of the world is constant.

2. The entropy (which is the measure of disorder of a system) tends to a maximum.

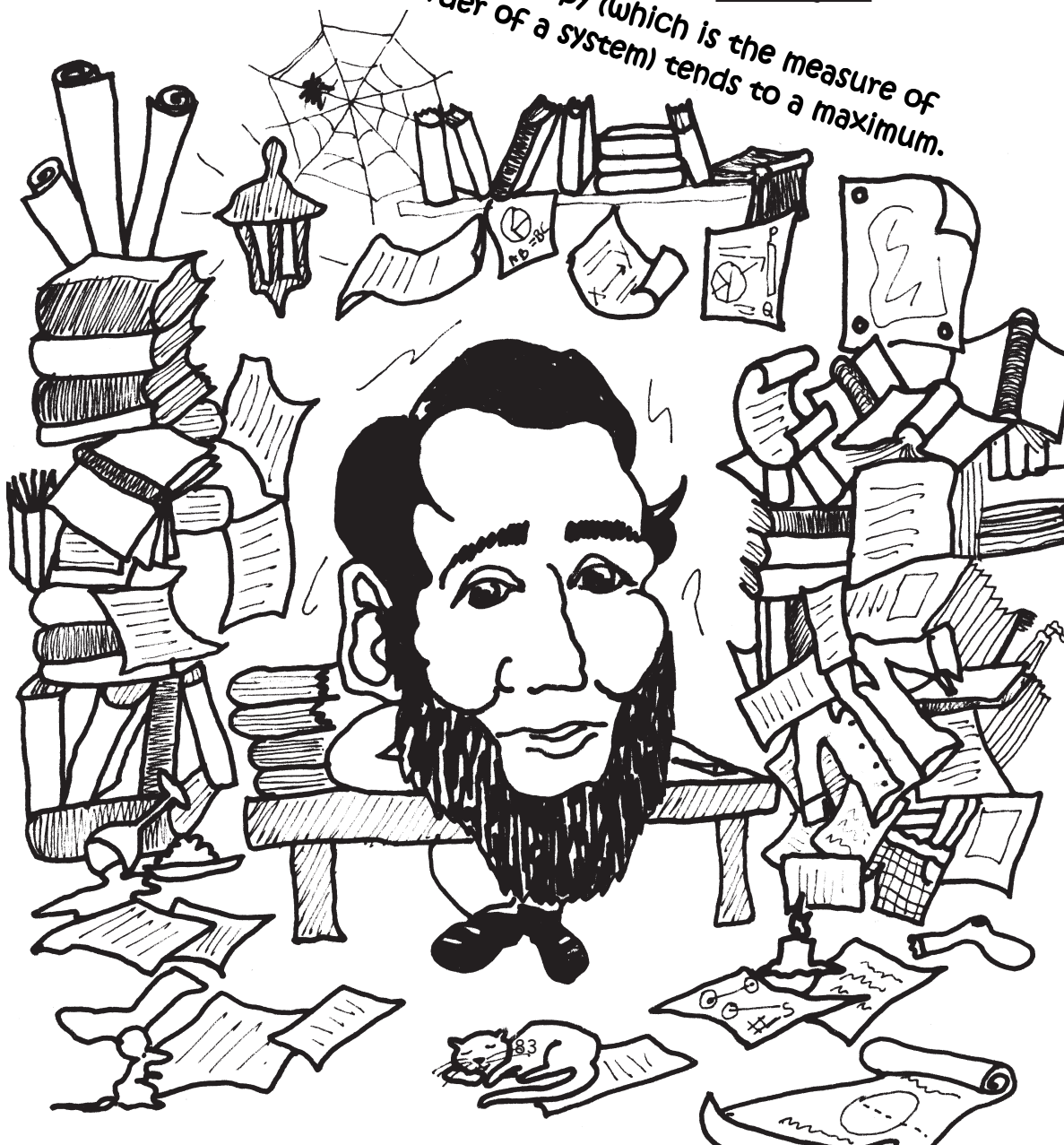

The **THIRD LAW** of thermodynamics would come much later.

Around 1905, **WALTHER NERNST** (1864 – 1941) while studying the behaviour of substances at very low temperatures, proposed one of the early version of the **Third Law**:

**Physical activities of substances tend to vanish as the temperature approaches absolute zero.**

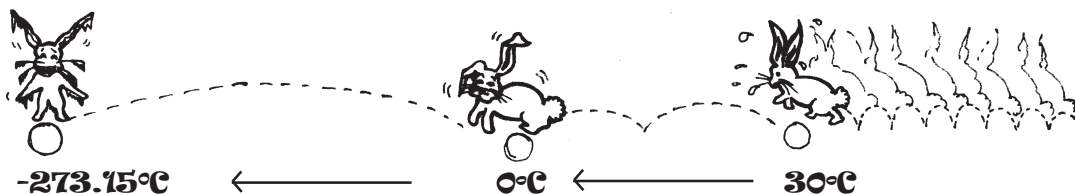

Thermochemical studies were made independently of these developments in thermodynamics.

## 1840. Germain Henri Hess

(1802 – 1850) observed,

“In a reaction, the same amount of overall heat is evolved no matter how many intermediate steps take place before a final product is obtained.”

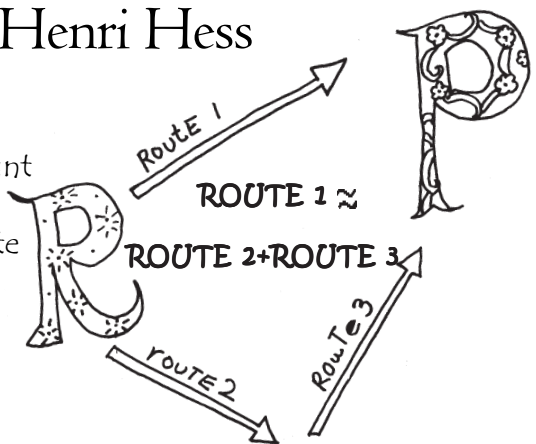

This **law of constant summation of heat** was actually a special case of the law of conservation of energy announced by Mayer two years later.

## 1878. Josiah Willard Gibbs (1839 –

1903) at Yale, United States developed the concept of **CHEMICAL POTENTIAL** that determines the direction of a chemical process: Chemical potential is analogous to electric potential. Just as electric current flows from a higher electric potential to a lower electric potential, when a reaction occurs, matter “flows” from a higher chemical potential to a lower chemical potential.

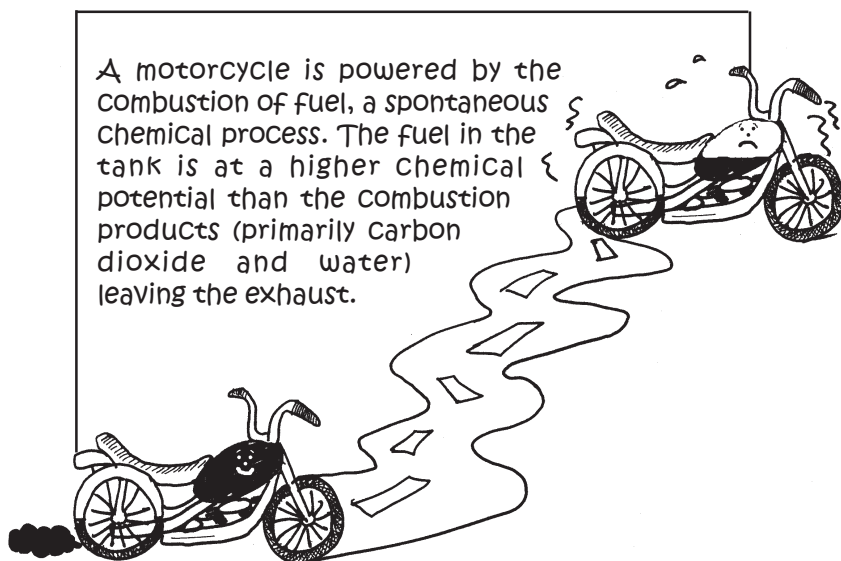

Gibbs also introduced the phase rule, which relates the number of components (C) and the number of phases (P, like solid, liquid, vapour) in a system to the number of degrees of freedom (F, the number of variables such as temperature and pressure that can be varied independently) by the equation

$$F=C+2-P$$

Austrian **Ludwig Boltzmann** (1844 – 1906) made pioneering contributions to the field of **statistical thermodynamics**. This field relates averages of molecular properties to thermodynamic quantities and describes thermodynamics at a molecular level.



I know how that works... to see if rice is cooked, I take a sample from the lower part of the pot and one from the upper part. If the rice is cooked in both parts, then I can be sure that all of it is cooked.



Much of kinetic theory of gases followed from statistical thermodynamics. Applying the methods of probability to describe the motion of gas molecules, Scottish physicist

**James Clerk Maxwell** (1831 –

1879) along with Boltzmann was able to show that the velocities of the molecules of a gas follow what we now call a Maxwell-Boltzmann distribution – a probability distribution whose mean and spread increases with increase in temperature.

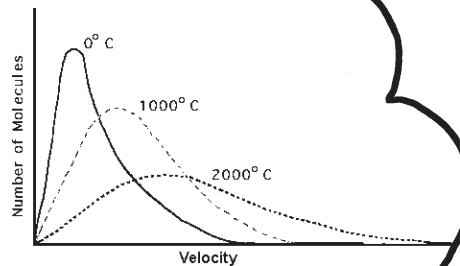

**1877** • Boltzmann published the most famous equation of statistical thermodynamics.

$$S = k_B \ln W,$$

$S$  is entropy,  $k_B$  is a constant and  $W$  is a quantitative measure of the disorder of a system. **This gives a relation between the thermodynamic quantity entropy and the statistical quantity  $W$ .** Statistical thermodynamics was developed at a time when the atomic nature of matter was not generally accepted, so Boltzmann's theory did not receive easy acceptance initially.

**Svante Arrhenius**, during his doctoral work at the University of Uppsala, Sweden in the early 1880s identified the basis for the conductivity properties of solutions: When certain compounds – electrolytes (for example salts) – are dissolved in water, a portion of it dissociates into positive and negative ions. Ions are responsible for carrying electricity through the solution.

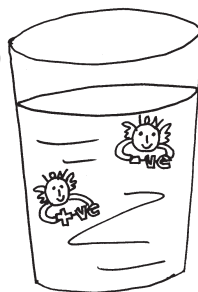

Impossible!  
Oppositely charged ions cannot exist separately in solution. No doctorate for Svante.



Maybe he is right.  
After all his theory does explain observation.



The scientific community later recognised his work and in 1903, Arrhenius was awarded Nobel prize for chemistry "for his electrolytic theory of dissociation."

As the 19<sup>th</sup> century was drawing to a close, chemistry had developed greatly. However, the nature of forces that held molecules together remained unanswered. The solution came with a major revolution of scientific ideas - the coming of the theory of ...

## QUANTUM MECHANICS.

To follow what led to this theory, let us begin with some experimental observations.

**1874.** William Crookes (1832 - 1919),

in his studies with a cathode ray tube noticed the turning of a small paddle wheel placed in the path of the rays.

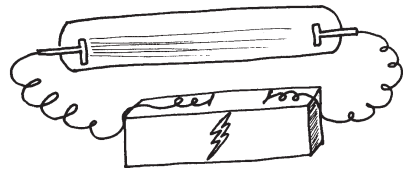

He found that the rays could exert force and consisted of particles. From their deflection in a magnetic field, he concluded that they carry a negative charge.

**1897.** Joseph John Thomson (1856 - 1940)

used a high vacuum to avoid interference by ionization of residual gases and made accurate studies of deflection of cathode rays in electric and magnetic fields. From this he could make better determinations of the charge to mass ratio and velocity of the particles.



"Cathode rays consist of negatively charged particles with a mass of **1/1845** that of the hydrogen atom."





The name “electron” had been coined earlier for the charge of the particles that carry electricity in conductors.

**G. F. FitzGerald** (1851 – 1901) proposed that the name electron be applied to these particles and this was universally accepted.

(Sigh) I think we will just go with electron, since we have used it all along anyway...

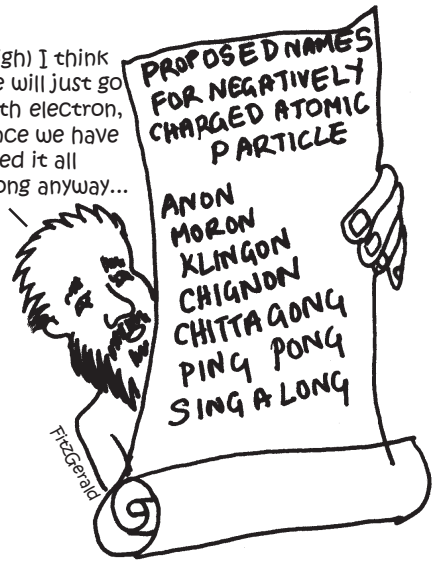

**1895.** *William Konrad Roentgen* (1845 – 1923) used black paper to cover a vacuum tube in which cathode rays were being generated. He noticed that crystals of barium platinocyanide placed near it fluoresced.

Some type of radiation was present and this could pass through solid matter, such as flesh, and cast shadows of denser objects, such as bones.

These X rays, as Roentgen called them, have since found great application in physics and chemistry as a spectroscopic tool and in medicine as a diagnostic technique. It is also used in security systems e.g. to scan baggage at airports.

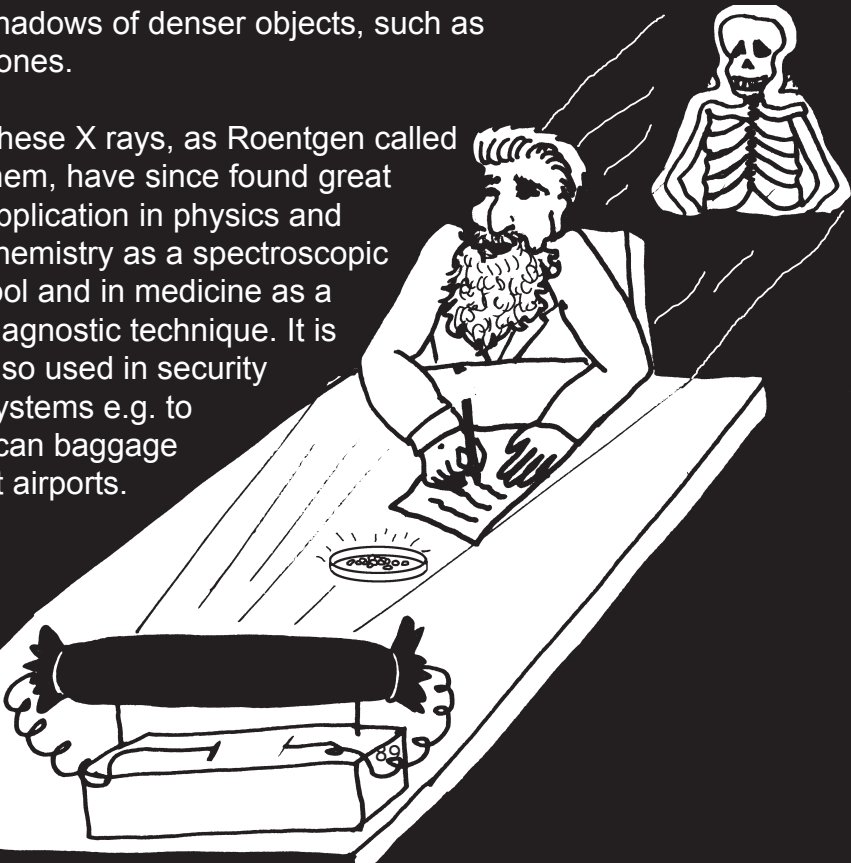

# 1896. ANTOINE HENRI BECQUEREL

(1852 – 1908)

“X rays caused fluorescence. Perhaps the opposite is true, that is fluorescing bodies produce X rays.

These uranium salts are known to fluoresce when exposed to sunlight. I wonder if they will produce X rays after exposing them to sunlight. Let me keep a photographic plate wrapped in black paper along with some uranium salt, ready for the experiment tomorrow.”

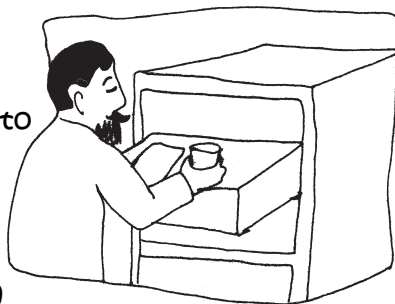

A series of cloudy winter days in Paris hindered his plans.



After few days he developed the photographic plate anyway.



“This is unbelievable, the plate is fogged! There must be some new kind of rays that are causing the plate to fog. These must be emitted spontaneously by the salt and can pass through non-transparent objects.”

Further studies showed that **uranium** was the source of the radiation.

**Marie Skolodowska Curie** (1867 – 1934), a young Polish scientist and her husband, the French physicist, **Pierre Curie** (1859 – 1906), began studying this phenomenon and suggested the name **radioactivity** for it.

They obtained a large supply of waste uranium ore, pitchblende, from the Austrian government and worked on isolating uranium from it. They soon discovered that the radioactivity from the ore exceeded that expected from uranium.



There must be a new element in the ore which is responsible for this large radioactivity. We have to isolate it!



Marie Curie

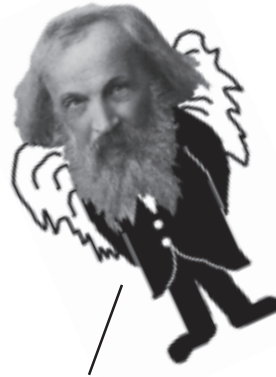

“Yes, there is room in my table for a new element.”

MARIE AND PIERRE TOILED INCESSANTLY ON PURIFYING A TON OF ORE TO A FEW GRAMS OF RADIOACTIVE SUBSTANCE. THEY SUCCEEDED IN SHOWING THAT THE ORE CONTAINED TWO NEW RADIOACTIVE ELEMENTS, POLONIUM AND RADIUM. BY A LONG SERIES OF LABORIOUS FRACTIONAL CRYSTALLIZATIONS, THEY FINALLY ISOLATED A SMALL QUANTITY OF PURE RADIUM SALT.



This salt was truly another one of nature's surprises! It glowed in the dark and emitted heat. It produced sores on the skin, sterilized seeds, healed surface cancer, electrified the air around it and its radiation penetrated solids.

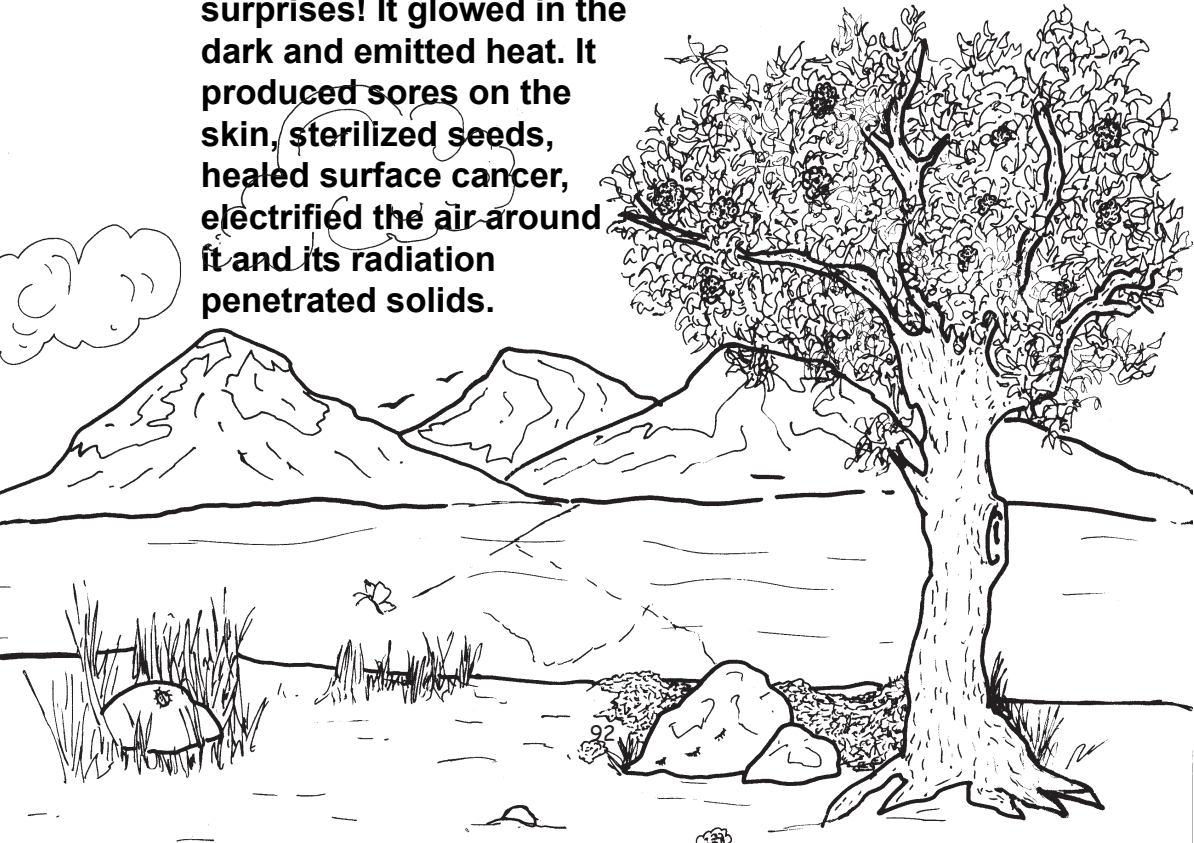

Marie Curie continued to study the properties of the new elements and wrote her doctoral dissertation on radioactivity in 1903. In the same year, she and her husband along with Henri Becquerel shared the Nobel prize for physics. Eight years later, after Pierre's death, Marie received another Nobel Prize this time in Chemistry.

In 1899, **ERNEST RUTHERFORD** found that two types of radiation were emitted from uranium. He called these  $\alpha$  and  $\beta$  rays and these were later identified as helium ions and electrons respectively. In 1900 **PAUL VILLARD** discovered a third type, the  $\gamma$  rays, which he recognised as similar to X rays. It was also realized that uranium was changing into some other substance.

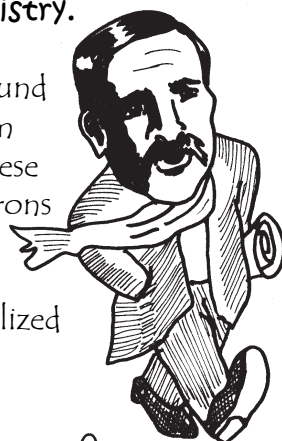

Rutherford and **FREDERICK SODDY** (1877 – 1956) gave a theory of atomic disintegration among radioactive substances resulting in the formation of new substances. This was verified and established by 1909.



### DISINTEGRATION SERIES

**Uranium-238**

↓  $\alpha$

Thorium-234

↓  $\beta$

Protactinium-234

↓  $\beta$

Uranium-234

↓  $\alpha$

Thorium-230

↓  $\alpha$

**Radium-226**

↓  $\alpha$

Radon-222

↓  $\alpha$

Polonium-218

↓  $\alpha$

Lead-214

↓  $\beta$

Bismuth-214

↓  $\beta$

**Polonium-214**

↓  $\alpha$

Lead-210

↓  $\beta$

Bismuth-210

↓  $\beta$

Polonium-210

↓  $\alpha$

**Lead-206**

The next question was on the structure of the atom, that is, to know the arrangement of the electrons and positive ions within the atom.

J. J. Thomson said, “The atom consists of uniform positive charge through which electrons are distributed, much like plums in a pudding.”



Rutherford and his students set up an experiment where they bombarded very thin gold sheet with  $\alpha$  particles (emanating from radium) and observed the trajectory of the  $\alpha$  particles.

Most of the  $\alpha$ -particle bombardiers passed right through, but some of these very high energy particles were deflected at a sharp angle as if they had struck something. Rutherford announced his theory to explain this in **1911**.



“The atom is composed of a heavy but relatively small nucleus where the positively charged particles are lumped together and outside it an equal number of negatively charged electrons are in motion around it.”

The charge of the nucleus is equal and opposite to the number of electrons and was given the name **atomic number**

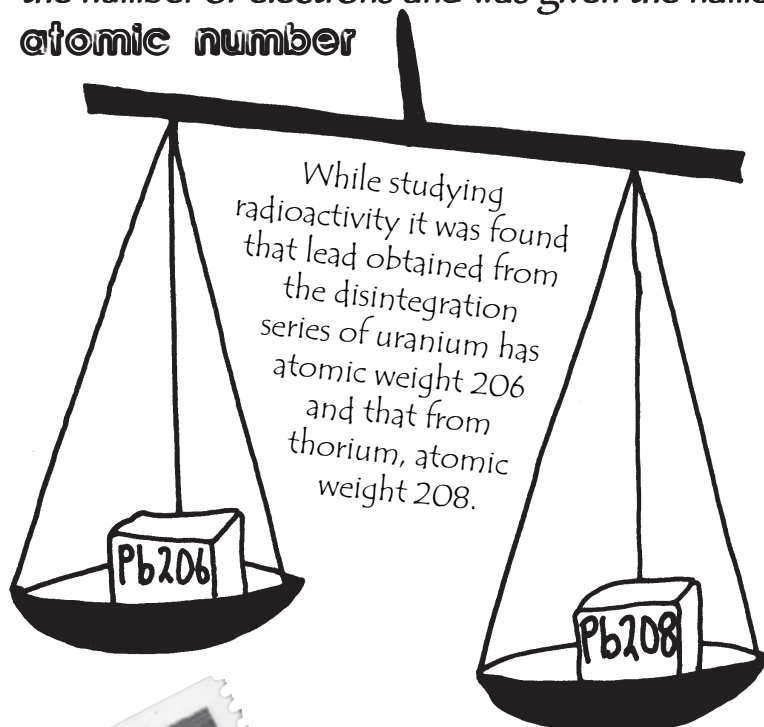

Swedish stamp in honour of Frederick Soddy

“Atomic number is more fundamental for an element than atomic weight. Elements with same atomic number but different atomic weights, we will call **ISOTOPES** from the Greek for ‘the same place’ that they occupy in the periodic table.”

Soddy received a Nobel Prize for Chemistry in 1921. By this time, he was deeply disturbed by the structure of the political economy within which science operated. This made him turn to a study of economics. His ideas about the relationship between money and society have been important in unorthodox traditions in modern economics.

## To get back to the structure of the atom...

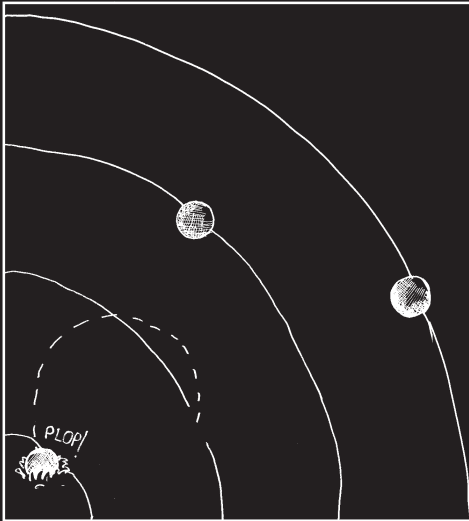

Rutherford's atom was like a miniature solar system. A problem with this picture was that since accelerated charged particles emitted radiation, an electron orbiting the nucleus would lose energy and fall into the nucleus and the atom would not be stable.

**NIELS BOHR** (1885 – 1962) of Copenhagen addressed this concern by applying the idea of quantization that was developed by **MAX PLANCK** (1858 – 1948) to the atom.

### 1913.



“Hello, I am a Niels Bohr doll. I am made of similar shells that fit into each other. Niels himself was very clever. He suggested that electrons can revolve around the nucleus with quantized angular momentum and therefore in only certain orbits or shells. In such a shell, the electron does not radiate. Electrons can jump between shells by absorbing or emitting energy. The outermost shell is responsible for the chemical properties of the element.”



The Bohr model was successful in explaining some properties of atoms, particularly their observed spectra.

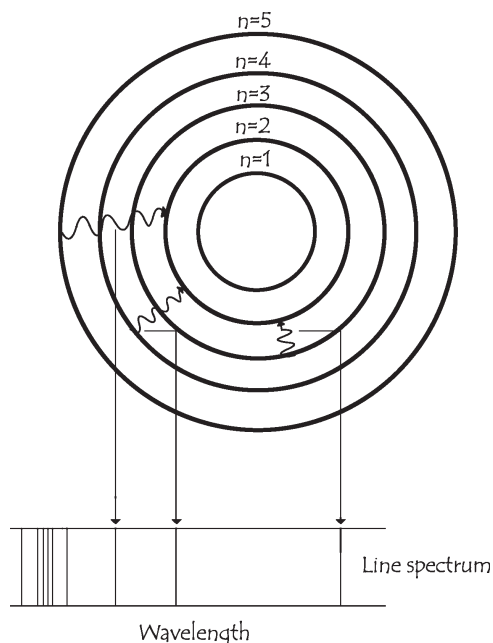

1916. G. N. Lewis (1875 – 1946)

and Walther Kossel (1888 – 1956) also

used the Bohr model to explain chemical affinity or bonding:

"Inorganic ions were formed by gain or loss of electrons in the outer shell to complete a STABLE OCTET with an electric charge. These ions were held together by electrostatic forces forming POLAR compounds with an IONIC BOND. Organic compounds, NON-POLAR in character are held together by sharing a pair of electrons in a COVALENT bond."



## 1925. Wolfgang Pauli (1900 – 1958) announced

his exclusion principle according to which each energy state or orbit could hold only two electrons. Thus electrons cannot just drop down to the lowest energy state. The periodic table could be correlated to the arrangement of electrons in the states.

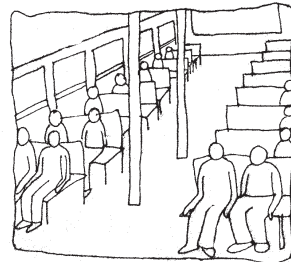
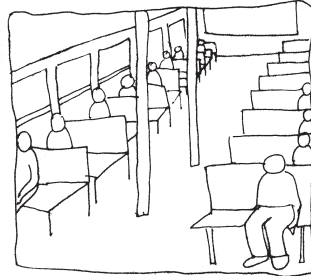
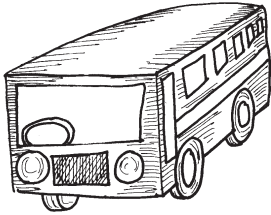

Electrons occupy states, in a manner similar to the way passengers occupy seats in an empty bus. The window seats generally fill up first, starting from the front of the bus. Once the window seats are filled in the bus, pairing begins, again from the front. Similarly, electrons prefer to be alone in a state and begin pairing when energy states are much higher in energy.

## 1924. Louis de Broglie (1892 – 1987)

proposed that material particles exhibit wavelike properties under certain conditions, just as radiation was known to exhibit particle like properties.

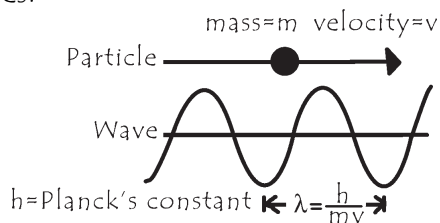

# 1925. Erwin Schrödinger

(1887 – 1961) and **Werner**

**Heisenberg** (1901 – 1976)

independently formulated a general **QUANTUM THEORY**, which would explain the behaviour of electrons, atoms and bonding of atoms in molecules.

Atoms and molecules are described by a **WAVE FUNCTION** which can be calculated mathematically and which completely specifies the system.

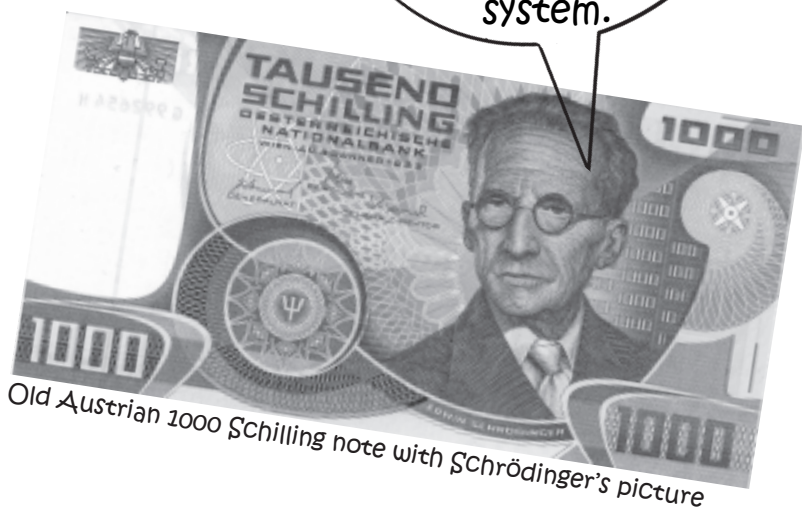

Old Austrian 1000 Schilling note with Schrödinger's picture

HEISENBERG'S FORMULATION was based on matrix algebra, but was shown to be equivalent to the wave mechanics formulation.



# 1926.

“The physical interpretation of the wave function of a particle is that, its square at a particular point is the probability density of finding the particle there.”

We looked at the formulation of quantum mechanics in the previous pages.

**Quantum mechanics** is the theory, which is the ultimate basis of our understanding of chemistry today. It explains the structure of the periodic table, molecular structure, bonding, reactivity, spectroscopy and so on. It thus unifies the different branches of chemistry.

Quantum mechanics is based on a set of postulates or axioms, like for example Classical mechanics is based on Newton's laws. The axioms of quantum mechanics are however less intuitive than Classical mechanics and we will not go into them here. The test of the theory is that it can explain and predict observation.

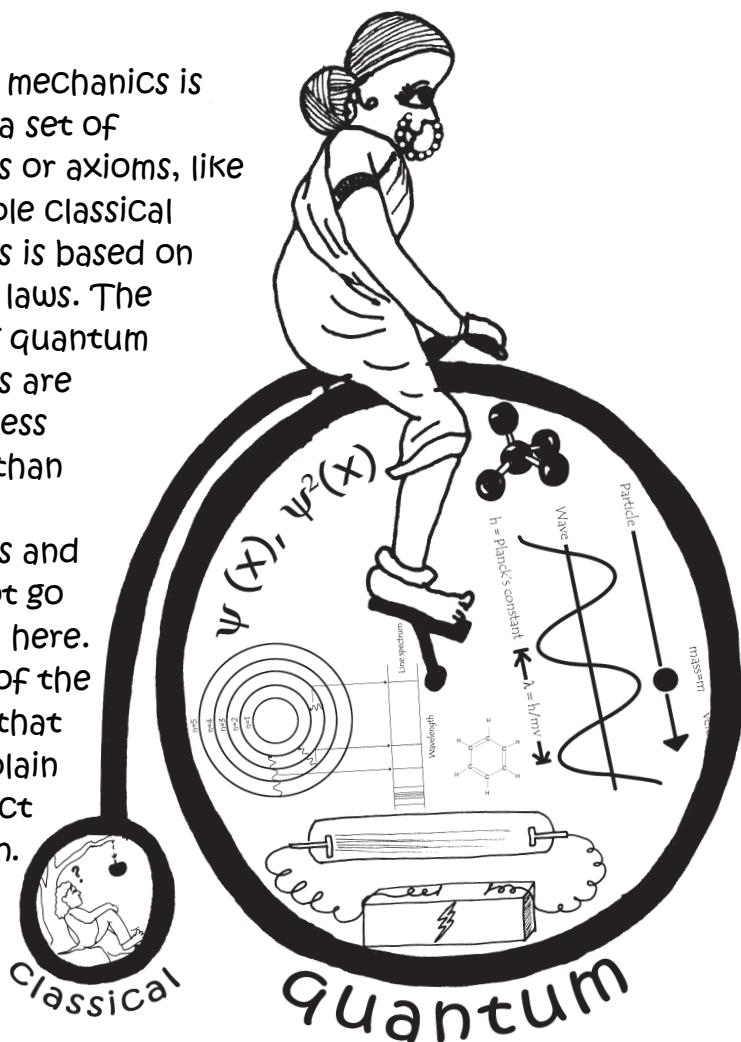

**1930s.** Quantum mechanics was applied to chemical systems to understand the structure and properties of molecules. This is

**Quantum chemistry.** One of the early champions of quantum chemistry was **Linus Pauling** (1901 – 1994) who developed a model to understand bonding called the **valence-bond** approach. His book, with the almost magical sounding title *The Nature of the Chemical Bond*, became one of the most influential works of the time. An alternative approach to bonding was pioneered by **Friedrich Hund** (1896 – 1997) and **Robert Mulliken** (1896 — 1986) called the **molecular-orbital** approach. These two approaches are complementary, each providing its own insights into chemical bonding.

**Douglas Hartree** (1897 – 1958) and **Vladimir Fock** (1898 – 1974) in the 1930s proposed a technique for the approximate calculation of the wave function of the molecule.



**1950s** Clemens Roothan developed a method where computers could be used to calculate the wave function and molecular properties. This is the subject area of **Computational chemistry**.

The methods have improved over the years and computers have become faster. Today, before carrying out a reaction in a laboratory (involving expensive chemicals and equipment) a chemist sitting at her computer can often get a reasonably accurate idea of the outcome of the reaction using computational chemistry. Of course, there are limitations of accuracy, particularly as the chemical system becomes large and so empirical studies continue to be important.



## Nuclear magnetic resonance (NMR)

spectroscopy gives information about the environment of an atom in a molecule and also the arrangement of its neighbouring atoms.

Spectroscopy plays a role not only to unravel the basic chemistry at the molecular level, but it provides an invaluable tool to scientists synthesizing new

compounds or designing new materials, by allowing them to look at their products.

Spectroscopy is also used by analytical chemists in pharmaceutical, petroleum and consumer product industries, for quality evaluation.

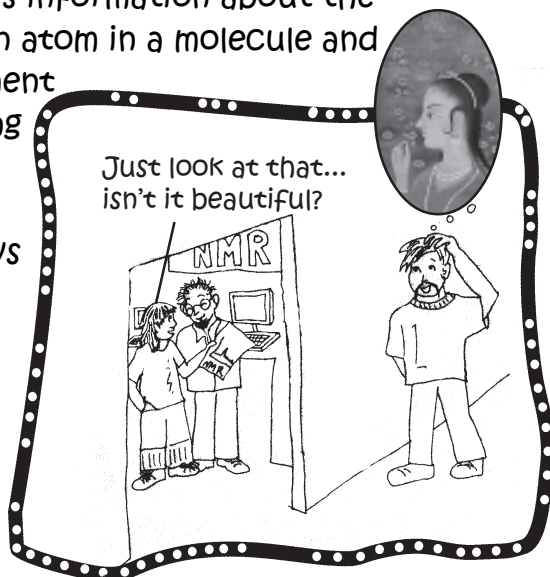

Moreover, spectroscopic techniques are frequently applied in medicine. For example, magnetic Resonance Imaging (MRI) works on the principle of NMR and is used to scan for tumours in the brain. It is also used by scientists trying to understand the functioning of the brain.

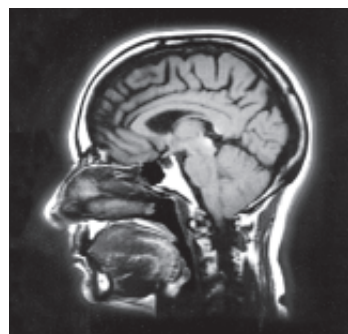

We have seen the close relation between the development of chemistry and physics in the beginning of the 20th century. The trend of chemistry crossing borders and having more to do with other disciplines, notably biology and material science besides physics, has continued through the twentieth century.

“Remember me? I am the Chem-monster you met in the 1800s. It’s been more than a century now - I’ve grown many more heads and become a lot more complicated. That’s because chemistry today is related to many other fields and all these fields too, are inter-related.”



The diversity and growth of chemical research in recent years has been simply enormous and in the next few pages we will sample just a few of these areas.



The **20<sup>th</sup> century** has added several new chemical elements to the periodic table, particularly those heavier than uranium. Uranium has the highest atomic number (92) of the naturally occurring chemical elements on earth. The effort to synthesize **artificial elements beyond uranium (transuranic elements)** began after **Irene** and **Frédéric Joliot-Curie** discovered **artificial radioactivity** in 1934. They bombarded light elements with alpha particles and produced radioactive isotopes of known elements that are not found naturally. This idea of bombarding with particles was used to create artificial transuranic elements. The first such element was **neptunium** (element 93), made in 1939.

Soon after in 1941 **Glenn Seaborg** (1912–1999) and his associates made **plutonium** (element 94) and went on to discover nine more transuranic elements. His last, element 106, was created in 1997 and named **Seaborgium** after him. As of year 2006, element 118, with the temporary name **Ununoctinium**, is the latest element to be created.

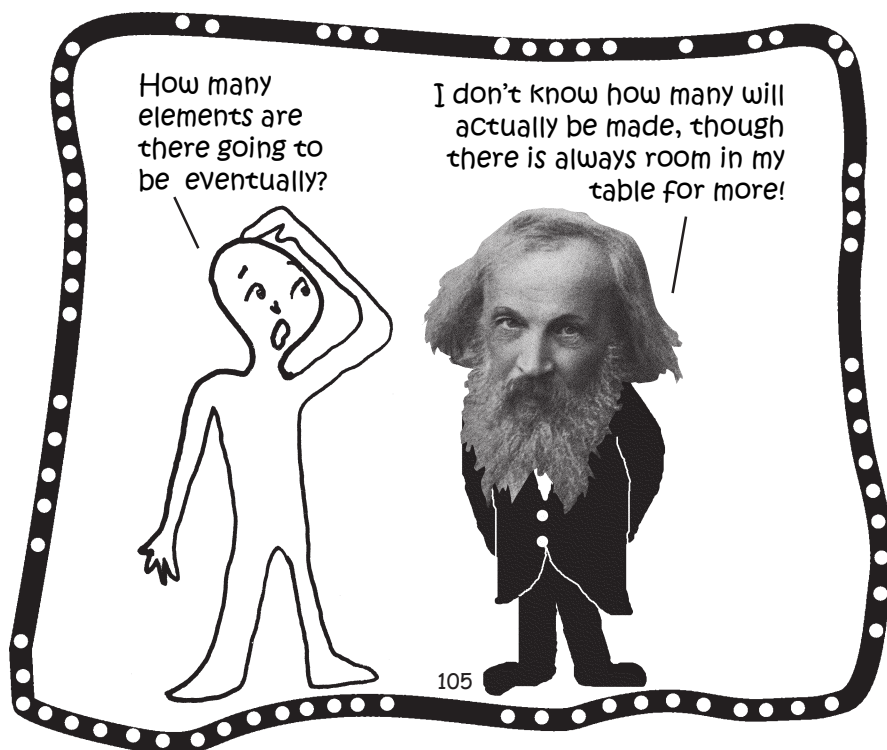

The understanding of the **C**hemistry of **L**ife increased rapidly in the twentieth century.

**Linus Pauling** who we have met as a pioneer of quantum chemistry, was a very versatile person. He worked on the molecular structure of amino acids, which are the building blocks of proteins, and in the late 1940's determined the fundamental structural pattern of many proteins, the so called  $\alpha$ -helix. In 1954 he was awarded the Nobel Prize in chemistry.

Pauling was also a peace activist. In 1958, he presented to the United Nations, a petition signed by 11,000 scientists from many countries, protesting further nuclear testing. His efforts were vindicated when a treaty was signed by the then three nuclear weapon owning nations — the US, UK and the USSR. Pauling was awarded a second Nobel Prize for peace in 1962.



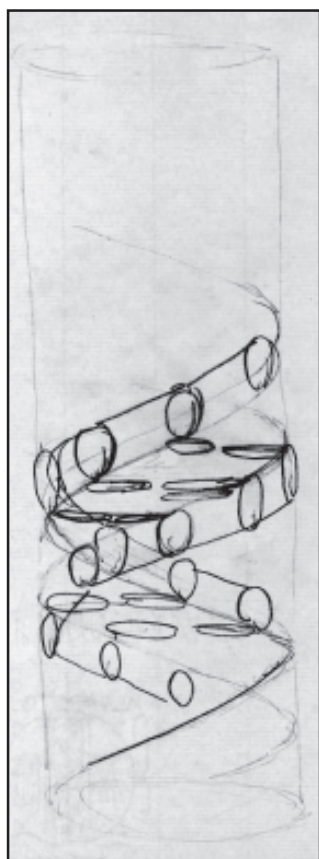
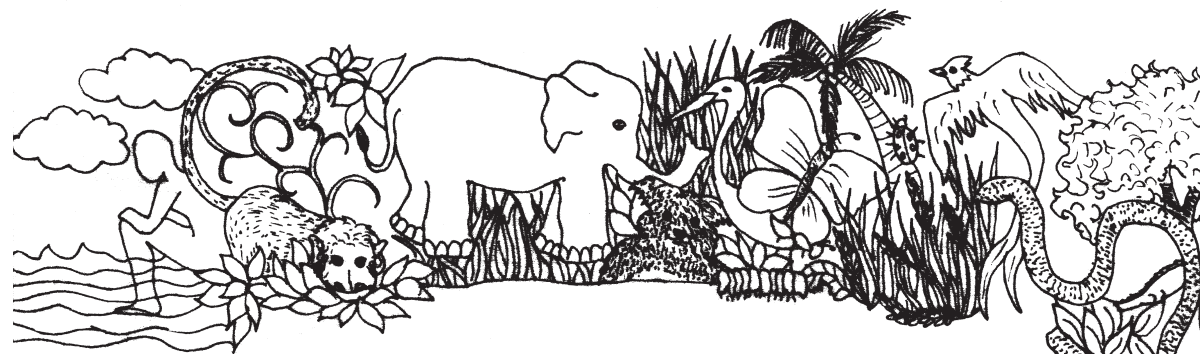

Sketch by Francis Crick, showing his first impression of the DNA molecule. c.1953

The information about a living system is passed to its future generation through a polymer called deoxyribonucleic acid (DNA). Together with other similar nucleic acids called the ribonucleic acids (RNA), DNA is also responsible for the synthesis of the various proteins needed by the cell to carry out its life functions. From the chemical composition of DNA and its X-ray crystallography photos, its structure was elucidated by JAMES WATSON (born 1928), FRANCIS CRICK (1916 – 2004), MAURICE WILKINS (1916 – 2004) and ROSALIND FRANKLIN (1920 – 1958) in 1953.

Today, the science of DNA, proteins and other biomolecules has directed the attention of a large body of chemists mainly because of its potential medical implications.



Chemists have synthesised various naturally occurring molecules in the lab. One of the most complex natural compounds synthesised to date is vitamin B<sub>12</sub>. **Robert Burns Woodward** (1917 — 1979) in collaboration with **Albert Eschenmoser** (1925 —) and a team of almost one hundred students and postdoctoral workers worked for many years on the synthesis of this molecule. The synthesis included almost a hundred steps. It was completed in 1971 and is a landmark in the history of organic chemistry.

In 1985, **Robert Curl** (1933 —), **HAROLD KROTO** (1939 —) and **Richard Smalley** (1943 —) made a sensational discovery of a new form of carbon. This stable molecule of carbon had sixty carbon atoms arranged in a closed shell like a soccer ball. Because of its similarity in shape also to the “geodesic dome” invented by architect Buckminster Fuller, they named this new carbon molecule **buckminsterfullerene**. Fullerene molecules have a beautiful structure and a great amount of research has taken place since their discovery to understand them better.

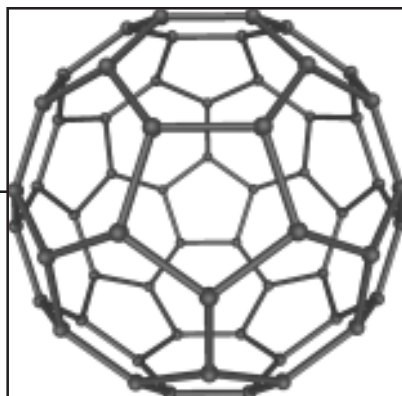

structure of buckminsterfullerene

A striking development in instrumentation was made in 1981 when **Gerd Binnig** (1947 —) and **Heinrich Rohrer** (1933 —) invented the **SCANNING TUNNELING MICROSCOPE**

(STM) based on the quantum mechanical effect of tunneling. The instrument scans an electrical probe, a sharp stylus, over a surface and detects a weak electric current flowing between the tip and the surface. The stylus is so sharp that its tip consists of only one atom!

Based on the current it is possible to map the surface of substances with amazing accuracy – to a point where individual atoms can be recognized.

During a reaction, chemical events at the molecular level occur rapidly and a technique to observe these was developed at the end of the 1980s, pioneered by **Ahmed Zewail** (1946 —). Short intense flashes of light that are a *femtosecond* ( $10^{-15}$  second) in duration are followed by spectroscopic analysis. This is the timescale on which chemical bonds are formed or broken and using this technique and relevant theoretical methods, we are able to understand reactions in unprecedented level of detail.

This is like using the world's fastest camera to film the molecules during the reaction and to get a sharp picture of the transition state.

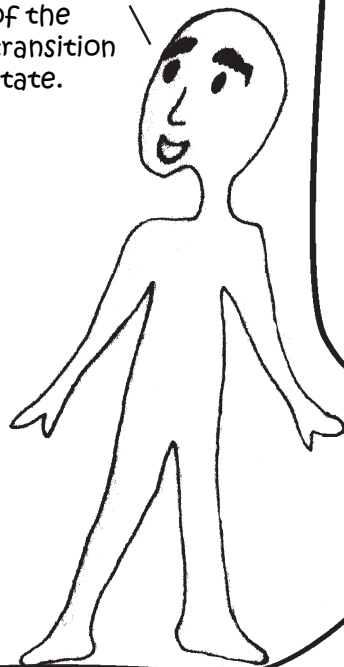

A commercial revolution has come about because of the industrial application of chemistry. Today plastics, rubbers, alloys with specific properties, catalysts to speed up industrial processes and materials for electronic technology are being used and invented like never before.

Let us consider the timeline of a class of industrial products – *synthetic polymers* or *plastics*. The first completely synthetic plastic was Bakelite invented in 1907 by **Leo H. Baekeland** (1863 – 1944). It was a rigid, lightweight material and used to make everything from hairbrushes to handles of frying pans. **Wallace Hume Carothers** (1896 – 1937) developed a new polyamide fibre which was marketed as ‘Nylon’ in 1938. In the early 1950s a new process for synthesizing polymers was discovered that made a lot of common plastics possible, including high-density polyethylene and polypropylene. **Karl Ziegler** (1898 – 1973) and **Giulio Natta** (1903 – 1979) were just two of several scientists who independently developed the process. Most polymers are insulators but in the late 1970s it was discovered that polymers can also conduct electricity. Conductive polymers are promising because they are much lighter than metals and potentially cheaper. They may play a very important role as conductors in the future.



Chemistry has made our material lives more comfortable than ever before, but the massive scale of industries and chemicals has also had an **impact on the environment**.

An example is the case of chlorofluorocarbons (CFCs) developed as a replacement for ammonia in refrigerators and also used as a propellant in spray cans. These CFCs are inert and able to reach the upper atmosphere without reacting, where they are decomposed by ultraviolet light from the sun, releasing chlorine atoms. Chlorine then combines with ozone, thus depleting the protective ozone layer of the earth. CFCs are being phased out since the 1990s, but this experience demonstrated the unforeseen consequences of the widespread use of a seemingly benign substance.

The challenge of protecting our environment while providing our needs presents opportunities to chemistry and science as a whole. We have seen chemistry bridging boundaries with other disciplines. We can hope that the resulting understanding of issues from a broader perspective, will help us overcome these challenges. It may form an interesting future chapter in the story of chemistry. We will have to wait and see.



# PERIODIC TABLE OF THE ELEMENTS

Dmitri Mendeleev (1834-1907)

**H**  
Hydrogen  
1



The Russian Chemist, Dmitri Mendeleev, was the first to observe that if elements were listed in order of atomic mass, they showed regular (periodical) repeating properties. He formulated his discovery in a periodic table of elements, now regarded as the backbone of modern Chemistry.

The crowning achievement of Mendeleev's periodic table lay in his prophecy of then, undiscovered elements. In 1869, the year he published his periodic Classification, the element gallium, germanium and scandium were unknown.

**Li**  
Lithium  
3



**Be**  
Beryllium  
4



Mendeleev left spaces for them in his table and even predicted their atomic masses and other chemical properties. Six years later, gallium was discovered and his predictions were found to be accurate. Other discoveries followed and their chemical behaviour matched that predicted by Mendeleev.

The remarkable man, the youngest in a family of 17 children, has left the scientific community with a Classification system so powerful that it became the cornerstone in chemistry teaching and the predication of new elements ever since.

**Na**  
Sodium  
11































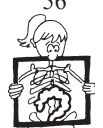



**Mg**  
Magnesium  
12



In 1955, element 101 was named after him: Md - Mendeleevium.

In this remarkable chart, originally prepared by the South African Agency for Science & Technology Advancement (SASTA) the elements are shown with an item of daily use. The symbols, names and atomic numbers of the elements are given.

*Redrawn by - Dr. Vidula Mhaiskar*

<b>K</b> Potassium 19 	<b>Ca</b> Calcium 20 	<b>Sc</b> Scandium 21 	<b>Ti</b> Titanium 22 	<b>V</b> Vanadium 23 	<b>Cr</b> Chromium 24 	<b>Mn</b> Manganese 25 	<b>Fe</b> Iron 26 	<b>Co</b> Cobalt 27 
<b>Rb</b> Rubidium 37 	<b>Sr</b> Strontium 38 	<b>Y</b> Yttrium 39 	<b>Zr</b> Zirconium 40 	<b>Nb</b> Niobium 41 	<b>Mo</b> Molybdenum 42 	<b>Tc</b> Technetium 43 	<b>Ru</b> Ruthenium 44 	<b>Rh</b> Rhodium 45 
<b>Cs</b> Caesium 55 	<b>Ba</b> Barium 56 	Lanthanide series <b>L</b>	<b>Hf</b> Hafnium 72 	<b>Ta</b> Tantalum 73 	<b>W</b> Tungsten 74 	<b>Re</b> Rhenium 75 	<b>Os</b> Osmium 76 	<b>Ir</b> Iridium 77 
<b>Fr</b> Francium 87 	<b>Ra</b> Radium 88 	Actinide series <b>A</b>	<b>Rf</b> Rutherfordium 104 	<b>Db</b> Dubnium 105 	<b>Sg</b> Seaborgium 106 	<b>Bh</b> Bohrium 107 	<b>Hs</b> Hassium 108 	<b>Mt</b> Meitnerium 109 